

**APPENDIX A 2012-ADVISORY ACTIVE SOIL GAS INVESTIGATION  
(DTSC/LARWQCB/RWQCB SF)**

**ADVISORY  
ACTIVE SOIL GAS INVESTIGATIONS**

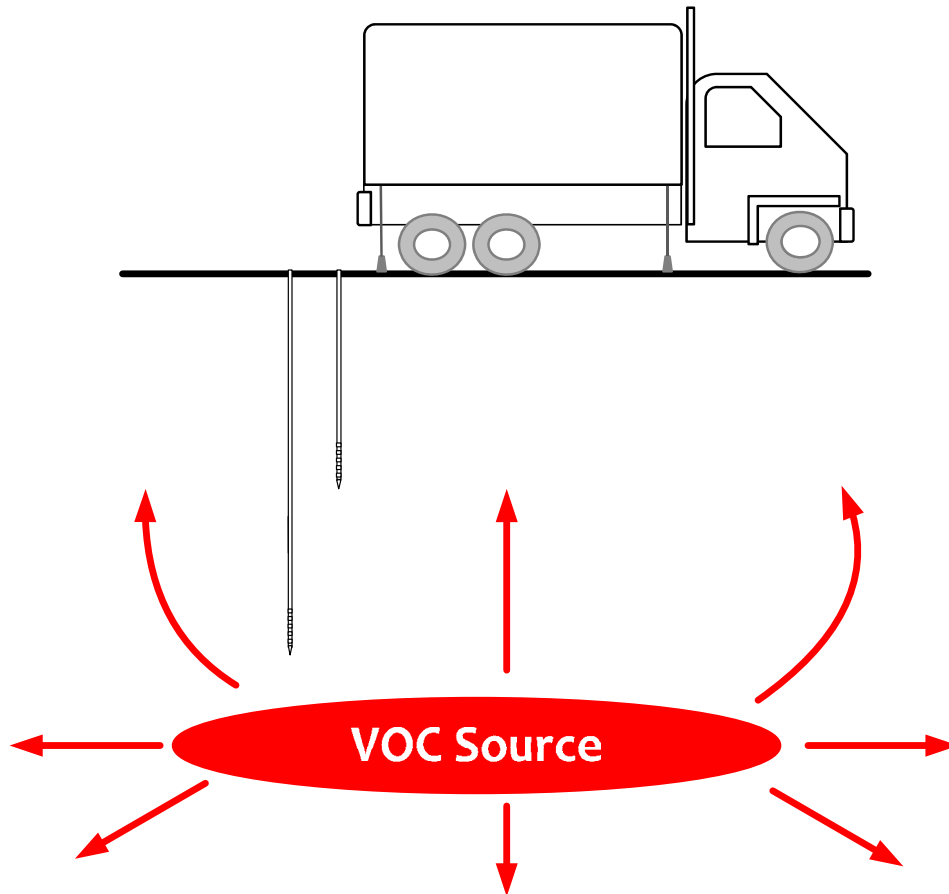

**California Environmental Protection Agency  
Department of Toxic Substances Control  
Los Angeles Regional Water Quality Control Board  
San Francisco Regional Water Quality Control Board**

**April 2012**

**FOREWORD**

In a coordinated effort, the Department of Toxic Substances Control, the Los Angeles Regional Water Quality Control Board, and the San Francisco Regional Water Quality Control Board have jointly developed the *Advisory – Active Soil Gas Investigations*. This document attempts to ensure that high quality data used for regulatory decision making are collected during active soil gas investigations using consistent methodologies. The document was reviewed by other government organizations and the regulated community. Their comments were considered and the Advisory changed in response to those comments. The Advisory also addresses recent developments in the field of soil gas collection. As additional information and experience are obtained, this Advisory may be modified as appropriate.

The information in the Advisory should not be considered as regulations. Mention of trade names or commercial products does not constitute the agency endorsement or recommendation.

If you have any questions or comments regarding this document, please contact Theodore Johnson of DTSC at via email at [tjohnson@dtsc.ca.gov](mailto:tjohnson@dtsc.ca.gov).

## ACKNOWLEDGMENTS

Preparation of this Advisory was achieved through the efforts of the following individuals at the California Environmental Protection Agency:

Rafat Abbasi	Department of Toxic Substances Control
Elizabeth Allen	San Francisco Bay Regional Water Quality Control Board <sup>1</sup>
Bill Bosan	Department of Toxic Substances Control
Phil Chandler	Department of Toxic Substances Control
Craig Christmann	Department of Toxic Substances Control
Dan Gallagher	Department of Toxic Substances Control
Joe Hwong	Department of Toxic Substances Control
Theo Johnson	Department of Toxic Substances Control
Dot Lofstrom	Department of Toxic Substances Control
Lynn Nakashima	Department of Toxic Substances Control
Yue Rong	Los Angeles Regional Water Quality Control Board
Thizar Williams	Los Angeles Regional Water Quality Control Board
Peter Wong	Department of Toxic Substances Control <sup>2</sup>

Also, David Berry, Ken Chiang, Rebecca Chou, Bryan Eya, Jeffrey Hu, and Christine Papagni provided invaluable assistance in the revision of this document. The California Environmental Protection Agency thanks them for their efforts.

This document was developed jointly under the direction of Debbie Raphael, Director, Department of Toxic Substances Control, Samuel Unger, Executive Officer, Los Angeles Regional Water Quality Control Board, and Bruce Wolfe, Executive Officer, San Francisco Regional Water Quality Control Board. Without their support, completion of this document would not have been possible.

The committee would like to acknowledge the contribution from soil gas practitioners that provided extensive and valuable comments, improving the overall quality of this document. More than 440 public comments on the Draft Advisory were received. Every comment was considered and the Advisory was changed in response to those comments. The Advisory was also revised to address recent developments in the field of soil gas collection. The Soil Gas Workgroup thanks all contributors for their efforts which improved the Advisory through their thoughtful observations.

---

<sup>1</sup> Currently with United States Environmental Protection Agency Region X.

<sup>2</sup> Currently with California Air Resources Board.

TABLE OF CONTENTS

	<u>Page</u>
FOREWORD.....	ii
ACKNOWLEDGMENTS.....	iii
ACRONYMS .....	vii
1.0 INTRODUCTION .....	1
2.0 INITIAL PROJECT PLANNING AND WORKPLAN DEVELOPMENT .....	2
2.1 Technical Documents .....	2
2.2 Workplan.....	2
2.2.1 Elements of the Workplan .....	3
2.2.2 Conceptual Site Model .....	4
2.2.3 Sampling and Analysis Plan.....	5
2.3 Soil Gas Investigation Reports.....	6
3.0 SOIL GAS INVESTIGATION DESIGN .....	8
3.1 Location, Spacing and Depth.....	8
3.1.1 Lithology.....	8
3.1.2 Sample Spacing .....	8
3.1.3 Sample Depth .....	8
3.2 Installation Procedures .....	9
3.2.1 Installation Methods and Design .....	9
3.2.2 Temporary and Permanent Wells.....	10
3.2.3 Sampling Tubing .....	12
3.2.4 Drive Point Method.....	12
3.3 Soil Gas Well Completion .....	13
3.4 Decommissioning .....	13
3.5 Decontamination.....	13
3.6 Sub-Slab Investigation Methods .....	14
4.0 SOIL GAS SAMPLE COLLECTION .....	16
4.1 Equilibration Time .....	16
4.2 Soil Gas Assembly Tests .....	16
4.2.1 Shut-In Test .....	17
4.2.2 Leak Test .....	17
4.2.2.1 Leak Check Compounds (Liquid).....	17
4.2.2.2 Leak Check Compounds (Gaseous).....	18
4.2.2.3 Leak Check Considerations .....	18
4.2.3 Purge Volume Test .....	19
4.2.4 Additional Purge Volume Tests.....	20
4.3 Purge/Sample Flow Rate and Applied Vacuum .....	20
4.3.1 Vacuum Pump.....	20
5.0 SAMPLE HANDLING AND TRANSPORT .....	22
5.1 Sample Containers .....	22
5.1.1 Syringes.....	22

## ADVISORY – ACTIVE SOIL GAS INVESTIGATIONS

5.1.2	Passivated Stainless Steel Canisters.....	22
5.1.3	Polymer Gas Sampling Bags or Glass Bulbs .....	22
5.1.4	Sorbent Tubes.....	23
5.1.5	Alternate Sample Containers .....	23
5.2	Field Conditions .....	23
5.2.1	Rainfall and Barometric Pressure (see Appendix G).....	23
5.2.2	Wet Conditions.....	24
5.2.3	Soil Gas Sampling in Low-Permeability Soil .....	24
5.2.4	Drilling Refusal.....	25
5.3	Sample Container Handling.....	25
5.3.1	Syringes and Glass Bulbs .....	25
5.3.2	Sorbent Tubes.....	25
5.3.3	Polymer Gas Sampling Bags .....	26
5.3.4	Passivated Stainless Steel Canisters.....	26
5.4	Sample Container Cleanliness and Decontamination .....	26
5.5	Chain of Custody Records .....	27
6.0	ANALYSIS OF SOIL GAS SAMPLES .....	28
6.1	Target Compounds .....	28
6.1.1	Common Organic Compounds.....	28
6.2	Reporting Limits for Target Compounds .....	29
6.3	Quality Assurance/Quality Control .....	29
6.3.1	Sample Blanks .....	30
6.3.2	Field Duplicate/Replicate Samples.....	31
6.3.3	Laboratory Control Samples .....	31
6.3.4	Split Samples .....	31
6.4	Holding Times.....	32
6.5	Analytical Methods.....	32
6.6	Soil Gas Sample Analysis and Laboratory Reporting .....	36
6.6.1	Analytical Methods.....	36
6.6.2	Contaminant Reporting .....	36
6.6.3	Leak Check Compounds.....	36
6.6.4	Auto Samplers.....	36
7.0	METHANE AND HYDROGEN SULFIDE SAMPLING PROGRAMS .....	37
7.1	Methane.....	37
7.1.1	Methane Field Collection.....	37
7.1.2	Methane Laboratory Analysis.....	37
7.2	Hydrogen Sulfide .....	37
7.2.1	Sample Containers.....	38
7.2.2	Hydrogen Sulfide Field Collection .....	38
7.2.3	Precautions Particular to Hydrogen Sulfide.....	38
8.0	LABORATORY CERTIFICATION.....	40
9.0	REFERENCES.....	41

**FIGURES**

Figure 1 Typical Single and Multiple Soil Gas Probe Design and Purge Volume Calculation ..... 11  
Figure 2 Sub-Slab Vapor Probe Typical Diagram ..... 15  
Figure C-1 Shroud Components ..... C-3  
Figure C-2 Shroud Components-Purge Conditions ..... C-4  
Figure G-1 Soil Drainage Curves (Gardner et al., 1970) ..... G-2  
Figure G-2 Soil Drainage Curves (Sisson et al., 1980) ..... G-3

**TABLES**

Table 1 Soil Gas Sample Holding Time ..... 32  
Table 2 Preferred Analytical Methods and Modifications ..... 33  
Table B-1 Tubing Type Study Results ..... B-2  
Table E-1 Comparison of Methodologies ..... E-5  
Table F-1 USEPA Soil Gas Testing Methods ..... F-3  
Table F-2 Advantages and Disadvantages of Sample Introduction Techniques ..... F-5  
Table F-3 Advantages and Disadvantages of Modifications to TO-15 ..... F-9  
Table F-4 Reporting Limits ..... F-19

**APPENDICES**

Appendix A Passive Soil Gas Method  
Appendix B Polymer Gas Sampling Bags and Tubing Types  
Appendix C Quantitative Leak Testing Using a Tracer Gas  
Appendix D Soil Gas Sampling in Low Permeability Soil  
Appendix E Naphthalene Soil Gas Collection  
Appendix F Soil Gas Analytical Method Review  
Appendix G Barometric Pressure, Rainfall, and Soil Drainage  
Appendix H Reporting Format and Parameters

ACRONYMS

AGSI	Active Soil Gas Investigation
AST	Aboveground Storage Tank
ASTM	American Society of Testing and Materials
BFB	Bromofluorobenzene
bgs	below ground surface
Cal/EPA	California Environmental Protection Agency
CHHSLs	California Human Health Screening Levels
COPC	Chemical of Potential Concern
CSM	Conceptual Site Model
DQO	Data Quality Objective
DTSC	Department of Toxic Substances Control
ECD	Electron Capture Detector
ELAP	Environmental Laboratory Accreditation Program
EPA	Environmental Protection Agency
ETBE	Ethyl Tertiary Butyl Ether
FID	Flame Ionization Detector
Freon 11	Trichlorofluoromethane
Freon 12	Dichlorodifluoromethane
Freon 113	1,1,2-Trichloro-1,2,2-Trifluoroethane
GC	Gas Chromatograph
GC/MS	Gas Chromatograph/Mass Spectrometer
CRWQCB	California Regional Water Quality Control Board
GEM	Gas Emission Monitor
ITRC	Interstate Technology and Regulatory Council
LARWQCB	Los Angeles Regional Water Quality Control Board
LCS	Laboratory Control Samples
L-D PE	Low Density Polyethylene
$\mu\text{g/L}$	Microgram per Liter
$\mu\text{g/m}^3$	Microgram per Cubic Meter
MS	Mass Spectrometer
MS/MSD	Matrix Spike/Matrix Spike Duplicate
MTBE	Methyl Tertiary Butyl Ether
mL/min	Milliliters per Minute
NELAP	National Environmental Laboratory Accreditation Program
NIST	National Institute of Standard and Technology
PAHs	Polycyclic Aromatic Hydrocarbons
PEEK	Polyetheretherketone
ppmv	Parts per Million by Volume
ppbv	Parts per Billion by Volume
PID	Photoionization Detector
PRT	Post-Run Tubing
RL	Reporting Limit
%RPD	Percent Relative Percent Difference
%RSD	Percent Relative Standard Deviation
PVC	Polyvinyl Chloride
QA/QC	Quality Assurance/Quality Control



**ACRONYMS (continued)**

QAPP	Quality Assurance Project Plan
SAP	Sampling and Analysis Plan
SIM	Selected Ion Monitoring
SOP	Standard Operating Procedure
SVOCs	Semi-Volatile Organic Compounds
SW-846	Solid Waste-846; USEPA Test Methods for Evaluating Solid Waste, Physical/Chemical Methods
TAME	Tertiary Amyl Methyl Ether
TBA	Tertiary Butyl Alcohol
TCE	Trichloroethylene or Trichloroethene
TICs	Tentatively Identified Compounds
TO-15	Toxic Organic-15 Analytical Method (USEPA, Compendium Method TO-15 for the Determination of Toxic Organic Compounds in Ambient Air)
TO-17	Toxic Organic-17 Analytical Method (USEPA, Compendium Method TO-17 for the Determination of Toxic Organic Compounds in Ambient Air)
TPH	Total Petroleum Hydrocarbons
USEPA	United States Environmental Protection Agency
UST	Underground Storage Tank
VOA	Volatile Organic Analysis
VOCs	Volatile Organic Compounds

## **1.0 INTRODUCTION**

The Advisory – Active Soil Gas Investigations (ASGI or Advisory) provides technically defensible and consistent approaches for collecting and analyzing soil gas samples. The Advisory is not a regulation. It does not impose any requirements or obligations on the regulated community. Rather, it provides a technical framework and reference for addressing soil gas sample collection and analysis. It is not intended to determine the need for soil gas samples, but rather to serve as a guide once a decision has been made to collect soil gas samples. Other technically equivalent procedures may exist. This Advisory is not intended to exclude alternative approaches or methodologies. The Advisory is a compilation of available information, knowledge, experience and best practices regarding soil gas sampling. The mention of trade names or commercial products in this Advisory is for illustrative purposes only, and does not constitute an endorsement or exclusive recommendation by the contributing government agencies.

Active soil gas sampling and analysis refers to the methods utilized to collect vapor phase data at sites potentially affected by volatile organic compounds (VOCs), chlorinated solvents, petroleum hydrocarbons, methane, hydrogen sulfide and semi-volatile organic compounds (SVOCs). The data obtained from a soil gas investigation can be used to identify the source and spatial distribution of contamination at a site or to estimate contaminant indoor air concentrations for risk assessment purposes. For guidance on evaluating the risk associated with vapor intrusion to indoor air, including sub-slab sampling, consult the DTSC Guidance for the Evaluation and Mitigation of Subsurface Vapor Intrusion to Indoor Air (October 2011), hereafter referred to as the Vapor Intrusion Guidance.

Within the subsurface, contaminants may exist in the following phases:

- 1) Solid phase by adsorbing onto the organic fraction of soil;
- 2) Aqueous phase by dissolving in groundwater and pore water;
- 3) Non-aqueous phase liquid (NAPL); and/or
- 4) Gaseous phase, by accumulating in the interstitial space of soil particulates as soil gas.

Thus, soil matrix and groundwater sampling and analysis should be considered for site characterization in addition to soil gas sampling to ensure that all potential phases of VOCs are evaluated and their associated exposure pathways. Soil gas sampling is practical and preferred for many geologic materials, and, with care, can be successful in fine-grained soils.

This document supersedes the 2003 *Advisory – Active Soil Gas Investigations* (Cal/EPA, 2003) and 1997 LARWQCB *Interim Guidance for Active Soil Gas Investigations* (CRWQCB, 1997). It is the opinion of Cal/EPA that active soil gas investigations should be performed in accordance with this document. However, as noted above, other technically equivalent procedures may exist, and this Advisory is not intended to exclude alternative approaches or methodologies.

## 2.0 INITIAL PROJECT PLANNING AND WORKPLAN DEVELOPMENT

### 2.1 STUDY PURPOSE AND DATA QUALITY OBJECTIVES

A soil gas investigation may be undertaken for a number of different reasons and a single investigation may have multiple objectives. The data quality objectives (DQOs) for each investigation will vary according to the overall goals of each specific investigation. Examples of different purposes for performing a soil gas investigation are provided below:

- Determining if discharges of contaminants have occurred which may impact indoor air, outdoor air and groundwater, such as leaks at aboveground storage tanks (AST), underground storage tanks (USTs) or other underground pollution sources;
- Determining the spatial patterns and extent of vapor phase soil contamination,
- Designing and monitoring the performance of a soil vapor extraction system;
- Mapping soil vapor plumes to select buildings for indoor air monitoring;
- Creating a stand-alone data set for performing a vapor intrusion risk assessment using either generic attenuation factors or a mathematical model to estimate indoor air concentrations from soil gas data;
- Remedy performance monitoring; and
- Providing data for no-further-action determinations at impacted sites.

The DQO process is a systematic planning tool based on the scientific method for establishing criteria for data quality and for developing data collection procedures. By using the DQO process to plan environmental data collection efforts, the effectiveness, efficiency and defensibility of decisions can be improved. DQOs should be established before an investigation is started. Example input parameters to the DQOs include past, current and future land uses, regulatory action levels for contaminated media, laboratory method reporting limits, and the appropriate sample collection method. The expected output is the most resource-effective design for the study. Information concerning DQOs is provided in USEPA (1994a, 1994b, 2000a). A critical step in developing site-specific DQOs is the generation of a conceptual site model (CSM), discussed below in Section 2.3.2.

### 2.2 TECHNICAL DOCUMENTS

Each soil gas investigation should have two technical documents: a workplan that describes the investigation in detail, and a report that describes the results of the investigation and the analysis of data. The workplan should incorporate the CSM and DQOs as a framework for the planned investigation. The CSM should be updated during the investigation as data gaps are addressed.

### 2.3 WORKPLAN

A workplan should be prepared and submitted to the regulating agency for review and approval according to the agreed upon schedule. Any variations or deviations from this Advisory should be specified in the workplan. The soil gas workplan may be incorporated as part of a comprehensive site investigation workplan or as a stand-alone

## **ADVISORY – ACTIVE SOIL GAS INVESTIGATIONS**

incorporated as part of a comprehensive site investigation workplan or as a stand-alone document, depending on site-specific circumstances. The workplan should include a CSM, sampling and analysis plan (SAP), and DQOs. The decision making criteria for step-out sampling should be included in the workplan.

The workplan should have contingences to address unexpected field conditions, such as larger than anticipated contaminant plumes, low flow or no flow conditions, and resampling when anomalous data are obtained. Anomalous data are defined as data which are inconsistent with the CSM. Additional points may be required to resolve anomalies.

The regulating agency should be informed of any problems, unforeseen site conditions or deviations from the approved workplan. If modifications to the approved workplan are going to be implemented, the regulating agency should be notified and provided an opportunity to review the changes prior to implementation. Changes made without prior agency approval should be clearly documented in subsequent reports, including justification for these changes.

The project proponent should notify the regulating agency 10 working days prior to implementation of field activities. All necessary permits and utility clearances should be obtained prior to conducting any investigations described in this Advisory.

### **2.3.1 Elements of the Workplan**

Specific information that the regulating agencies will expect to see in a workplan include the following:

- 1) Site background;
- 2) CSM;
- 3) A SAP that contains the number, location and depth of sampling points and the rationale for this decision;
- 4) A statement of the investigation objectives relative to the site-specific DQOs;
- 5) A statement as to whether permanent or temporary soil gas wells are to be installed. See DTSC (2011) for guidance concerning the need for the installation of permanent soil gas wells;
- 6) A statement as to whether a mobile and/or stationary laboratory will be used, and the rationale for making this decision;
- 7) A schematic diagram of the well design;
- 8) A schematic diagram of the sampling train;
- 9) A geological cross-section of the site showing the major lithologic units and zones for vapor monitoring;

## ADVISORY – ACTIVE SOIL GAS INVESTIGATIONS

- 10) Procedures for soil gas sample collection and the analytical methods to be used along with their laboratory detection limits;
- 11) Contaminant analyte list;
- 12) Considerations for sampling frequency pursuant to the DQOs established for each site;
- 13) Procedures to properly decommission soil gas wells to effectively prevent cross-contamination in the subsurface;
- 14) A project-specific quality assurance project plan (QAPP) for the project if no existing approved QAPP is applicable;
- 15) Procedures for handling and disposing of investigation-derived waste in accordance with federal, state and local agency requirements; and
- 16) A site-specific Health and Safety Plan.

### 2.3.2 Conceptual Site Model

A CSM is an integral part of all site investigations. The purpose of a CSM is to provide a conceptual understanding of the potential for exposure to hazardous contaminants at a site based on:

- Sources of contamination;
- Release mechanisms;
- Transport media;
- Exposure pathways; and
- Potential receptors.

The CSM also aids in the justification for the number, location and frequency of samples. The CSM should consist of descriptive text and diagrammatic or schematic figures relating the sources of contamination to receptors and the environment. The CSM organizes and communicates information about the site characteristics and provides all interested parties with an understanding of the potential for exposure to chemicals of potential concern (COPCs) at a site. Additional resources regarding CSMs include: (1) DTSC, 2011; (2) ITRC, 2007; (3) DTSC, 1994; (4) USEPA, 1988; (5) USEPA, 1989; and (6) USEPA, 1994.

The basic components of a CSM are:

- 1) Type of contaminants, including VOCs, currently or previously stored or handled at the site, to develop a site-specific target analyte list;
- 2) Known concentrations of COPCs in media such as soil gas, soil and groundwater;
- 3) Identification of the primary and secondary sources of COPCs;

## ADVISORY – ACTIVE SOIL GAS INVESTIGATIONS

- 5) Primary release mechanism;
- 6) Exposure media such as surface soil, drinking water and air;
- 7) Potential human and ecological receptors and groundwater; and
- 8) Unique site features.

The CSM is a dynamic and iterative tool, and is updated as new information becomes available. Therefore, it should be reviewed after each stage of investigation and revised as appropriate.

The following information should be considered to identify contaminant sources, potential release mechanism(s) and pathway(s) for vapor migration:

- Soil types;
- Subsurface geology;
- Hydrogeology (local and regional), including depth to groundwater and groundwater flow direction;
- Subsurface heterogeneity;
- Preferential pathways, such as fractures, sand lenses, and utility corridors;
- Groundwater quality data;
- Regional groundwater flow direction;
- Well records;
- Boring logs;
- Building construction details; and
- Surficial features of the area, such as ground cover and surface water bodies.

A CSM should be supported by contaminant plume maps and geological cross sections. The narrative description should clearly describe known site conditions and state what assumptions were made to generate the CSM.

### 2.3.3 Sampling and Analysis Plan

The SAP should specify all procedures and techniques used for soil gas sample collection, shipment, analytical procedures and chain of custody documentation. Field personnel should follow the SAP while collecting and analyzing soil gas samples.

The SAP should identify proposed sampling points, known or inferred extent of contamination, potential or known areas of concern and pertinent features such as existing or former sumps, trenches, utility corridors, drains, sewer lines, clarifiers, septic systems, piping, ASTs, USTs and waste management units. Generally, the SAP should contain:

- Sampling objectives;
- Sample location and frequency;
- Pre-sampling activities;
- Sample equipment and collection procedures;
- Sample handling and analyses;
- Chain of custody control and records management;
- Analytical procedures;

## **ADVISORY – ACTIVE SOIL GAS INVESTIGATIONS**

- Field instrument and laboratory detection limits;
- Field and laboratory quality assurance/quality control (QA/QC); and
- Evaluation of data quality.

The SAP should also contain a quality assurance project plan describing the policy, organization, activities and protocols necessary to achieve the data quality objectives dictated by the intended use of the data. The QAPP should include the following applicable information:

- Project description, management/organization and responsibilities;
- Quality assurance objectives;
- Sampling, calibration and analytical procedures;
- Data acquisition, reduction, validation and reporting;
- Documentation;
- Internal quality control;
- Performance and systems audits;
- Preventative maintenance;
- Data assessment procedures;
- Corrective actions; and
- Quality assurance reports.

Project tasks and time lines, including dates anticipated for initiating and completing sampling activities should also be included in the SAP.

### **2.4 SOIL GAS INVESTIGATION REPORTS**

A soil gas investigation report should be submitted to the regulating agency at the conclusion of the investigation. Electronic data files should be submitted in accordance with the electronic data format requirements of the oversight agency.

Reports should include the following information:

- Description of field operations (including purge testing and leak check compounds);
- Analytical methods used;
- Analytical results;
- Analysis and revision of the CSM based on data obtained from the soil gas investigation;
- Deviations from the approved workplan;
- Data inconsistencies;
- Data gaps identified based on the revised CSM; and
- Conclusions and recommendations.

Additionally, the following tables and diagrams should be included in the Report:

- 1) Site plan and sample location maps;

## ADVISORY – ACTIVE SOIL GAS INVESTIGATIONS

- 2) Plume maps and geologic cross sections with isoconcentration contours displaying the limits of contamination. Data from previous investigations may be included provided the data are presented in a way that distinguishes them from the current investigation;
- 3) Boring logs;
- 4) Construction and as-built diagrams for soil gas wells;
- 5) Summary tables for analytical data;
- 6) Legible copies of field and laboratory notes or logs;
- 7) All analytical results and QA/QC information including tables and explanation of procedures, results, corrective actions and effect on the data;
- 8) All raw data including chromatograms and calibration data if specifically requested by the regulating agency; and
- 9) Electronic data deliverables submitted in the format specified by the regulating agency.

All engineering or geologic work should be performed or supervised by a California Registered Professional in accordance with the Business and Professions Code, chapters 7 and 12.5, and the California Code of Regulations, title 16, chapters 5 and 29.



### 3.0 SOIL GAS INVESTIGATION DESIGN

The number, location and depth of soil gas samples should be based on the CSM and the project-specific DQOs, as well as the following general guidelines.

#### 3.1 LOCATION, SPACING AND DEPTH

Subsurface contamination should be delineated three-dimensionally. Vertical soil gas delineation is achieved by collecting soil gas samples at varying depths in a single location, or by using closely spaced soil gas wells installed at varying depths.

##### 3.1.1 Lithology

Locations and depths for soil gas monitoring wells should be based on site-specific lithologic information. If on-site lithologic information is not available prior to conducting the soil gas investigation, one or more continuously cored boring(s) should be installed at the first location to the proposed greatest depth of the soil gas investigation. If the soil gas data are to be used for human health risk assessment, geotechnical data may be needed. Geotechnical information needed for vapor intrusion risk assessment purposes can be found in DTSC's Vapor Intrusion Guidance (DTSC, 2011).

Lithologic logs should be prepared for all borings, including soil matrix and geotechnical borings. Information gathered from the continuously cored borings may include lithologic descriptions, geotechnical data and contaminant data. Information collected from borings should be used to update the CSM. All boring logs generated during the soil gas survey should be provided to the regulating agency.

##### 3.1.2 Sample Spacing

Sample spacing may be based on historical site use or known or potential release sources. Initial spacing can be grid-based such as samples spaced on a 50- by 50-foot grid. Alternatively, initial sampling can be based on historical or suspected site use. When areas of contamination are identified, a more focused grid spacing or biased sampling approach may be employed. Use a close interval grid or radial or step-out sampling pattern such as 10- to 20-foot grid pattern and multi-level sampling at 5-, 10-, 15-feet vertically to delineate identified contaminant areas. If historical information for the area is unknown, a screening grid pattern, such as 100- by 100-foot may be used.

##### 3.1.3 Sample Depth

All available information such as boring logs and field instrument readings from soil cuttings or cores should be used to select the correct depths to collect soil gas samples. Probes should be installed at depths with elevated vapor readings and/or slightly above fine-grained soils. If vertical characterization to groundwater is needed, the deepest soil gas sample should be collected near the top of the capillary fringe. Soil gas wells or probes<sup>3</sup> should not be installed within or below the capillary fringe. Nested soil gas wells

---

<sup>3</sup> The term "soil gas monitoring well", "soil gas well", "soil vapor well", and "soil vapor probe" are considered equivalent and used interchangeably within the Advisory.

## **ADVISORY – ACTIVE SOIL GAS INVESTIGATIONS**

may be installed in the annular space of groundwater monitoring wells to serve as a dual-purpose well if both vapor and groundwater monitoring are required.

Soil gas sample depths should be chosen to minimize the effects of changes in barometric pressure and temperature, breakthrough of ambient air from the surface, and to ensure that representative samples are collected. Soil gas samples collected at less than 5 feet below ground surface (bgs) may be subject to barometric pressure effects and prone to breakthrough of ambient air through the soil column. Consideration should be given to source location, types of chemicals of concern and the lithology encountered. Variation of sample depths and the need for deeper sample locations should be evaluated based on site-specific characteristics and DQOs.

When evaluating vapor intrusion, sampling soil gas immediately adjacent to a building's foundation may be a viable option if the samples are collected near the contaminant source. Soil gas samples collected immediately above the source of contamination are more likely to be representative of what may be in contact with the building's foundation (Hers et al., 2006 and DiGiulio and Cody, 2006). Likewise, the numerical modeling conducted by Abreu and Johnson (2005) and Abreu and others (2006) also suggests this relationship. Hence, risk estimates may be biased low if quantified with shallow soil gas measurements (five feet below grade) using the Johnson and Ettinger (1991) model. Accordingly, collecting soil gas samples near contaminant sources is recommended for vapor intrusion modeling. Vertical soil gas sampling should be conducted to determine the source of subsurface contamination. Ideally, numerous vertical profiles of soil gas should be developed at the site to accurately locate subsurface sources. Once located, soil gas collection can be targeted at these depths site-wide. Typically, contaminant sources are adjacent to the areas of highest subsurface concentration.

### **3.2 INSTALLATION PROCEDURES**

Soil gas well installation procedures are described below. Soil gas well construction should ensure a good seal between the formation and sampling assembly, and minimize ambient air breakthrough. Additional standards may be required by local oversight agencies.

#### **3.2.1 Installation Methods and Design**

Soil gas wells may be installed using a variety of drilling methods such as direct push, hollow stem auger or hand auger. Certain drilling methods that significantly disrupt soil gas equilibrium, such as air rotary and roto-sonic, may be employed if longer equilibration times are used prior to sampling. The mud rotary drilling method is not acceptable for soil gas probe emplacement under any circumstances. Following is a step-by-step guide to soil gas well (probe) installation after the borehole has been drilled:

- 1) Install a sand pack to minimize disruption of airflow to the sampling tip. A tremie pipe should be used for soil gas wells deeper than 15 feet to avoid bridging or segregation during placement of the sand pack and bentonite seal. The sand

## ADVISORY – ACTIVE SOIL GAS INVESTIGATIONS

pack should be a minimum of six inches thick. Place the probe tip midway in the sand pack, as shown on Figure 1;

- 2) Emplace at least six inches of dry granular bentonite on top of each sand pack, as shown on Figure 1. Following the dry bentonite, fill the borehole to the surface with hydrated bentonite. The bentonite should be hydrated in a container at the surface and then slowly poured into the borehole. The purpose of the dry granular bentonite between the sand pack and the hydrated bentonite is to prevent hydrated bentonite from infiltrating the sand pack. Follow a similar procedure for deep well construction with multiple probe depths, in that one foot of dry granular bentonite should be emplaced on top of the sand pack encasing each probe, followed by hydrated bentonite. The hydrated bentonite should continue until the next sand pack, as shown on Figure 1. A cement/bentonite mixture may also be used above the dry bentonite layer to seal the borehole annulus, consistent with California Department of Water Resources Bulletin 74-90 (California Well Standards) (DWR 1991). Dry and hydrated bentonite layer thicknesses may be adjusted based on probe use (such as sub-slab probes).
- 3) A down-hole rod should be used to support the well tubing in the borehole. The support rod ensures that the probe tip is placed at the proper depth. The support rod should be constructed to avoid possible cross contamination or ambient air intrusion. Alternative probe support designs with accompanying descriptions may be proposed in the project workplan. Justification should be included in the project workplan if the project proponent chooses not to use probe support for deep soil gas wells.

### 3.2.2 Temporary and Permanent Wells

Permanent or temporary soil gas wells may be used for collecting samples. Permanent sampling points are installed so that repeated sampling can be conducted, as necessary, to evaluate seasonal or temporal variations. Temporary sampling points are typically used for one or two sampling events and then decommissioned in accordance with Section 3.4 of this Advisory.

**ADVISORY – ACTIVE SOIL GAS INVESTIGATIONS**

Figure 1

Typical Single and Nested Soil Gas Probe Design & Purge Volume Calculation

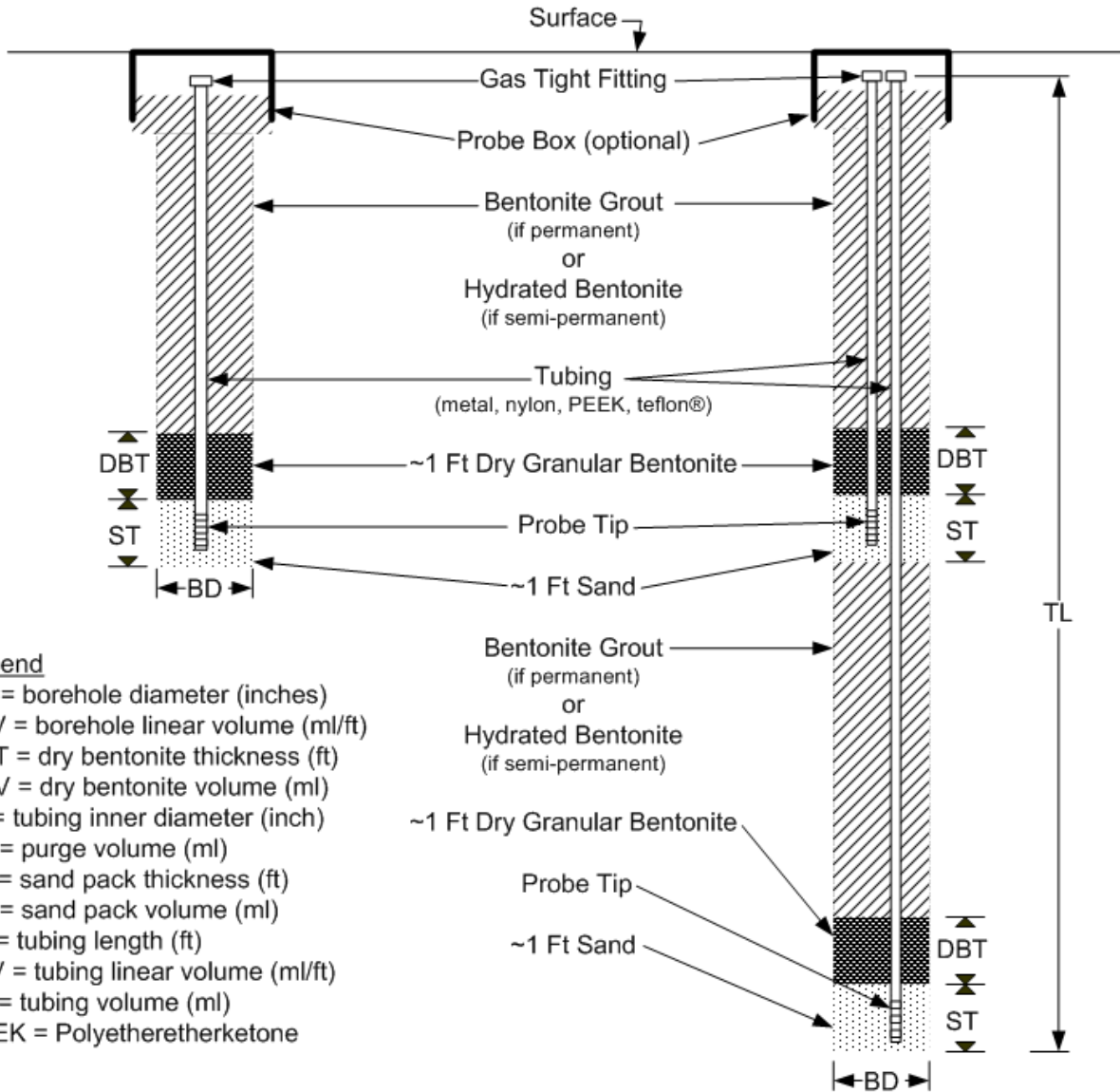

**Legend**

- BD = borehole diameter (inches)
- BLV = borehole linear volume (ml/ft)
- DBT = dry bentonite thickness (ft)
- DBV = dry bentonite volume (ml)
- ID = tubing inner diameter (inch)
- PV = purge volume (ml)
- ST = sand pack thickness (ft)
- SV = sand pack volume (ml)
- TL = tubing length (ft)
- TLV = tubing linear volume (ml/ft)
- TV = tubing volume (ml)
- PEEK = Polyetheretherketone

(1)  $TV = TL \times TLV =$           ml

X 6 if tubing ID = 3/16" = \_\_\_\_\_ ml  
 X 16 if tubing ID = 5/16" = \_\_\_\_\_ ml  
 X \_\_\_ if tubing ID = \_\_\_" = \_\_\_\_\_ ml

(2)  $DBV = DBT \times BLV =$           ml

X 350 if BD = 2 1/8" = \_\_\_\_\_ ml  
 X 820 if BD = 3 1/4" = \_\_\_\_\_ ml  
 X \_\_\_ if BD = \_\_\_" = \_\_\_\_\_ ml

(3)  $SV = ST \times BLV =$           ml

X 280 if BD = 2 1/8" = \_\_\_\_\_ ml  
 X 660 if BD = 3 1/4" = \_\_\_\_\_ ml  
 X \_\_\_ if BD = \_\_\_" = \_\_\_\_\_ ml

Note: porosity of 50% used for dry bentonite and 40% used for #3 sand pack to calculate BLV.

1  $PV = (1)TV + (2)DBV + (3)SV =$           ml

### 3.2.3 Sampling Tubing

To minimize purge volume, use small diameter (1/8 to 1/4 inch) sampling tubing from the vapor probe tip to the ground surface, made of material which will not react or interact with site contaminants. The probe tip, probe and probe connectors should all have the same diameter to provide a good seal between the formation and the sampling assembly. The following steps will help ensure a good-quality soil gas sample.

- 1) Clean, dry tubing should be used at all times. If any moisture or unknown material is present in the tubing prior to insertion, decontaminate or replace the tubing;
- 2) The bottom-end of the tubing should be attached to a soil gas probe tip. Downhole equipment (probe screens, tie wires, etc.) or drive heads should be free of cutting oils and other contaminants;
- 3) Metal tubes should not be used to collect hydrogen sulfide samples. Nylaflow<sup>®</sup>, polyetheretherketone (PEEK), and Teflon<sup>®</sup> are recommended for soil vapor sampling. Low-density polyethylene (L-D PE) should not be used due to decreased performance relative to other tubing types in both off-gassing of VOCs inherent in the tubing structure (contribution to background) and for decreased contaminant recovery (reactivity). Reduced recovery of naphthalene was observed when using Nylaflow<sup>®</sup> tubing with small sample sizes. For additional information, see Appendix B;
- 4) Prior to sampling, an assembled soil gas probe, tip and tubing should be blank tested at a frequency of one analysis per new batch of tubing or material used.

### 3.2.4 Drive Point Method

Post-run tubing (PRT) and drive point methods<sup>4</sup> used to create temporary soil gas wells may be used to rapidly acquire soil gas samples when carefully installed. Contractors should ensure that installation includes regularly checking and cleaning of the PRT tip threads and its seat and changing the O-rings on a daily basis. Contractors should use stiff tubing to couple the PRT tip to the connective hose and use ¼ inch outer diameter, thick-wall tubing to ensure sufficient torque is available to screw the tip tightly into the seat. If the O-ring is not seated properly into the drill rod, ambient air from inside the rod could enter into the sampling system, introducing ambient air into the soil gas sample. The integrity of the seal of the O-ring cannot be readily evaluated with a leak check compound.

Representative soil gas samples may be difficult to obtain with PRT and drive point methods in certain lithologies. Drive point probes may be deflected by consolidated lithologies and strata containing cobbles or boulders, which can create gaps between

---

<sup>4</sup> Drive point methods may be appropriate for certain site conditions or circumstances depending on DQOs. The use of post-run tubing should be discussed with the regulating agency prior to inclusion in the workplan.

## **ADVISORY – ACTIVE SOIL GAS INVESTIGATIONS**

the outer wall of the drive rod and the subsurface that are difficult to observe and equally difficult to seal. A hydrated bentonite plug at ground surface does not stop communication along the annular space. Samples collected under these circumstances will potentially draw soil gas primarily from the most permeable layer above the probe tip which may introduce a significant bias. Moreover, this condition is difficult to identify by a leak check compound applied at or near ground surface. Collecting representative soil gas samples in these conditions may require alternative sampling methods such as passive soil gas sampling or the installation of permanent sampling wells.

### **3.3 SOIL GAS WELL COMPLETION**

Soil gas wells should be secured, capped and completed to prevent infiltration of water or ambient air into the subsurface, and to prevent accidental damage or vandalism. Mark the tubing at the surface to identify the probe location and depth. For surface completions, the following components may be installed:

- Gas-tight valve or fitting for capping the sampling tube;
- Utility vault or meter box with ventilation holes and lock;
- Surface seal; and
- Guard posts.

### **3.4 DECOMMISSIONING**

When sample collection ceases at a vapor well, properly remove or decommission wells with concurrence from the regulating agency. The decommissioning process should prevent the well and associated borehole from becoming a conduit for the preferential migration of contamination. The decommissioning procedures within the California Well Standards (Bulletin 74-90) should be followed along with any local requirements.

When decommissioning vapor wells with tubing, the following decommissioning steps should be followed:

- 1) Squeeze sealant, such as grout, cement or silicone caulk, into the exposed tubing until the entire tubing is filled with material;
- 2) Cut the well tubing as far below grade as possible;
- 3) Fill the open hole with hydrated bentonite to within one foot of the surface grade;
- 4) Fill the last foot of the hole with compacted native material; and,
- 5) Restore pavement and vegetation to original conditions, if needed.

When overdrilling vapor wells with ridged casing, a casing guide should be used to prevent the drill bit from drifting during the decommissioning. A casing guide will allow the drill bit to remain aligned on the top of the well casing, allowing for effective removal of the well material. Once the well material is removed, the borehole should be filled with bentonite grout. If vapor wells penetrate clay units, consideration should be given to overdrilling rather than abandonment in place in order to prevent preferential contaminant migration.

### **3.5 DECONTAMINATION**

Decontaminate all reusable equipment to prevent cross contamination. Tubing is not reusable and should not be decontaminated. Instead, use new or unused sampling tubing for each probe location.

Decontamination may consist of steam cleaning or a three-stage decontamination process consisting of a wash with a non-phosphate detergent, a rinse with tap water and a final rinse with distilled water. Collect one equipment blank at the beginning of sampling and at least one each day after decontamination. Equipment should be air-dried before reuse.

### **3.6 SUB-SLAB INVESTIGATION METHODS**

The procedures for collecting sub-slab soil gas samples are the same as for collecting subsurface soil gas samples except that small sampling canisters should be used to minimize ambient air breakthrough into samples. USEPA (2006) recommends that the sampling canisters should be one liter or less. Methods for installing sub-slab vapor probes can be found in the DTSC Vapor Intrusion Guidance (DTSC, 2011, Appendix G). A typical sub-slab probe design is included in this document as Figure 2. The probe tubing should extend to the bottom of the foundation slab to effectively bypass any cracks within the slabs at the probe location. It is critical to seal off the probe to ambient air to obtain high quality data.

FIGURE 2  
Sub-Slab Vapor Probe Typical Diagram

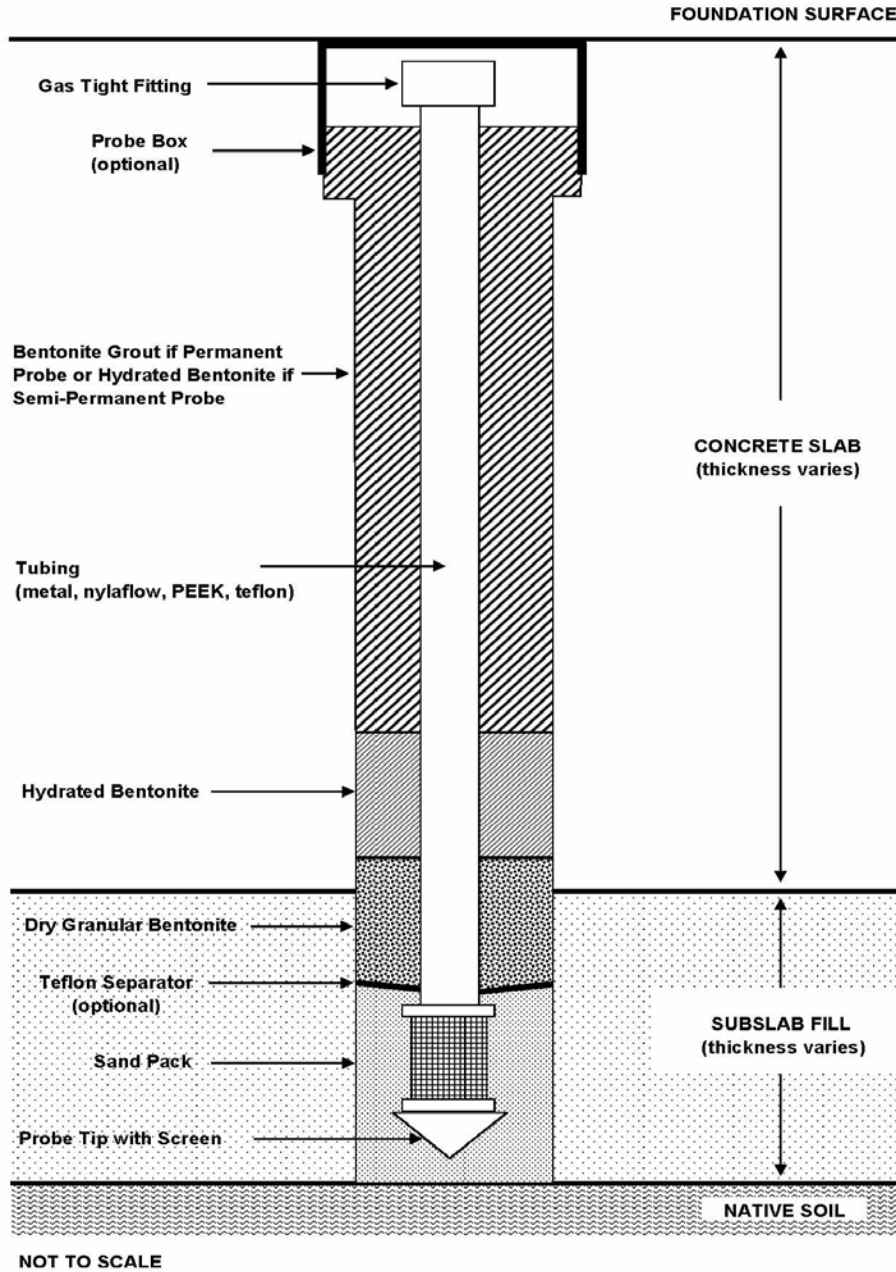



## 4.0 SOIL GAS SAMPLE COLLECTION

### 4.1 EQUILIBRATION TIME

Subsurface conditions are disturbed during drilling and probe placement. To allow for the subsurface to equilibrate back to representative conditions, the following equilibration times are recommended before proceeding with soil gas sampling:

- 1) For soil gas wells installed with the direct push method, do not conduct the purge volume test, leak test and soil gas sampling for at least two hours following vapor probe installation;
- 2) For soil gas wells installed with hollow stem or hand auger drilling methods, do not conduct the purge volume test, leak test and soil gas sampling for at least 48 hours after soil gas probe installation;
- 3) For soil gas wells installed with a combination of hand auger drilling or hollow stem auger and direct push methods, do not conduct the purge volume test, leak test and soil gas sampling for at least two hours following vapor probe installation provided that at least five feet of the borehole was drilled by direct push technology. The five feet of direct push borehole should be drilled after the completion of hand augering or hollow stem augering. The well screen should be located below this five-foot interval. If the well screen is located above the five-foot interval, do not conduct the purge volume test, leak test and soil gas sampling for at least 48 hours after soil gas probe installation; and
- 4) For soil gas wells installed with the roto-sonic or air rotary method, do not conduct the purge volume test, leak test, and soil gas sampling until it can be empirically demonstrated that the subsurface equilibrium time is sufficient to collect representative samples. Due to site-specific conditions, the re-establishment of equilibrium could vary from a few days to a few weeks.

**Note:** The best option to verify that equilibrium has re-established is to collect time-series data. Soil gas samples, along with oxygen and carbon dioxide measurements, should be collected shortly after installation, and then at a frequency that will demonstrate the time needed to attain representative samples. A field instrument may be used to analyze the soil gas samples to evaluate representativeness. Assuming similar lithology, one monitoring point could serve as a surrogate for all others when installing multiple sampling probes. For differing lithologies, see Additional Purge Volume Tests section below.

Soil gas well installation method and equilibration time should be recorded in the field log book or field form.

### 4.2 SOIL GAS ASSEMBLY TESTS

Complete shut-in, leak, and purge volume tests before collecting soil gas samples after the soil gas well has equilibrated.

### 4.2.1 Shut-In Test

Prior to purging or sampling, a shut-in test should be conducted to check for leaks in the above-ground sampling system. To conduct a shut-in test, assemble the above-ground valves, lines and fittings downstream from the top of the probe. Evacuate the system to a minimum measured vacuum of about 100 inches of water using a purge pump. The test is conducted while the sampling canister, if used, is attached with its valve in the closed position. Observe the vacuum gauge connected to the system with a “T”-fitting for at least one minute or longer. If there is any observable loss of vacuum, the fittings are adjusted until the vacuum in the sample train does not noticeably dissipate. After the shut-in test is validated, the sampling train should not be altered. The vacuum gauge should be calibrated and sensitive enough to indicate a water pressure change of 0.5 inches. A shut-in test is not a replacement for a leak test.

### 4.2.2 Leak Test

A leak test is used to evaluate whether ambient air is introduced into the soil gas sample during the collection process. Atmospheric leakage occurs in three ways:

- 1) Advection through voids in the probe packing material and along the borehole sidewall;
- 2) Advection directly through the soil column; and
- 3) Through the fittings in the sampling train at the surface (Banikowski et al, 2009).

A leak test should be conducted at every soil gas well each time a soil gas sample is collected to evaluate the integrity of the sample. Introducing ambient air may result in an underestimation of actual site contaminant concentrations or, alternatively, may introduce external contaminants into samples from ambient air.

The two types of leak check compounds available for use when soil gas sampling are liquid compounds and gaseous compounds. Both types have their advantages and disadvantages, and practitioners should select a leak check compound based on their project's DQOs. See Appendix C for quantitative leak testing.

#### 4.2.2.1 LEAK CHECK COMPOUNDS (LIQUID)

Liquid tracer compounds, such as hexane, pentane, difluoroethane and isopropanol, can be used to evaluate sample integrity. Other compounds not listed here may also be appropriate. Typically, liquid tracer compounds are applied to towels or clean rags and placed around all connections in the sampling train in order to evaluate potential leaks of ambient air into the sampling train. The liquid tracer should not be directly sprayed or poured onto a fitting, but rather applied to a cloth which should be placed near the connection. Towels or rags with the liquid tracer should also be placed on the ground adjacent to the probe to evaluate soil column and probe construction breakthrough. The leak check compound selected should not be a suspected site-specific contaminant. Seal integrity is confirmed by analyzing the soil gas sample for the tracer compound. Alternatively, each connection can be individually checked by placing the tracer cloth in a plastic bag and then using the bag to enclose individual connections. Instruments can

## ADVISORY – ACTIVE SOIL GAS INVESTIGATIONS

be used in the field to evaluate whether leakage is occurring rather than waiting for the mobile or stationary laboratory results. Liquid leak check compounds should be included in the laboratory analyte list. The laboratory reports should quantify and annotate all detections of the leak check compound at the reporting limit of the target analytes. If the concentration of the leak check compound is greater than or equal to 10 times the reporting limit for the target analyte(s), then corrective action is necessary as discussed below.

### 4.2.2.2 LEAK CHECK COMPOUNDS (GASEOUS)

Gaseous tracer compounds, such as helium and sulfur hexafluoride, can be used along with a shroud or tent placed over the sampling equipment. Other compounds not listed here may also be appropriate. Procedures for conducting a quantitative leak test are described in Appendix C. An ambient air leak up to 5 percent is acceptable if quantitative tracer testing is performed by shrouding.

### 4.2.2.3 LEAK CHECK CONSIDERATIONS

A soil gas well should be decommissioned if the leak cannot be corrected. Replacement soil gas wells should be installed at least five feet from the location where the original soil gas well was decommissioned due to a confirmed leak. The leak check compound concentrations detected in the soil gas samples should be included in the laboratory report and the ambient air breakthrough should be discussed in the site characterization report.

The intent of the leak check compound is to enhance the integrity of the soil gas sample by demonstrating that minimal or no ambient air breakthrough during sampling is occurring. Although it is preferable not to have any tracer gas breakthrough, minor amounts of breakthrough may be acceptable if the breakthrough is appropriate for the site's DQOs. Detecting leak check compounds indicate potential field problems. Some potential sources of leaks in sampling trains are poor quality fittings, stripped, over tightened, dirty or worn threads, and excessive sampling train connections. Regardless of the cause of the leak, a data adjustment factor based upon the concentration of the leak check compound to compensate for the inability to collect representative samples is inappropriate.

Note that if a passivated stainless steel canister is used to collect a sample that is later analyzed at a stationary laboratory and there is a significant leak, it will typically not be identified until after demobilization of the field crew. Therefore, field screening prior to laboratory analysis is recommended.

Commercially available leak check compounds, both liquid and gaseous, may contain unanticipated impurities. Therefore, laboratories should analyze the leak check compound to aid in the interpretation of the data.

When designing a field study, the tracer compound should be carefully selected. The following items should be considered when choosing a tracer compound.

- Excessive concentrations of the tracer can elevate analytical detection limits;

## ADVISORY – ACTIVE SOIL GAS INVESTIGATIONS

- Tracer compounds can cause interference with target analytes;
- Field detectors may produce biased results in the presence of water vapor or other compounds;
- The tracer compound may be naturally occurring;
- Field detectors may not be routinely calibrated; and
- Pressurized canisters of tracer gas may be dangerous to transport.

### 4.2.3 Purge Volume Test

The purpose of a purge volume test is to ensure that stagnant air is removed from the sampling system and to ensure that samples are representative of subsurface conditions. The purge volume test should be completed after the shut-in and leak test. The test well should be located near the contaminant source zone and in a lithologic unit where soil gas concentrations are anticipated to be elevated. The purge volume test is conducted by collecting and analyzing a sample for target compounds after removing one, three and 10 purge volumes. The purge volume test samples should be analyzed with the same analytical method as the constituents of concern.

One purge volume includes the following volumes:

- The internal volume of tubing;
- The void space of the sand pack around the probe tip; and
- The void space of the dry bentonite in the annular space.

For permanent probes subject to frequent sampling, the purge volume can be reduced to one tubing volume if sufficient time, typically two weeks, has transpired between sampling events to allow the filter pack to come into equilibrium with the surrounding soil and the probe has remained sealed to ambient air. Sample containers are not included in the purge volume calculation except when non-evacuated glass bulbs are used. In those instances, the volume of the non-evacuated glass bulbs should be added to the purge volume to account for mixing and dilution of gasses inside the glass bulb.

Conduct the purge test at the same flow rate and applied vacuum as will be used to collect the soil gas samples. If the pump is battery-operated, the batteries should be checked before and during the operation to insure that a proper charge is maintained. As batteries lose charge the flow rate is lowered, effectively changing the purge rate. Select the appropriate purge volume based on the highest concentration of the compound(s) of concern detected during the purge volume test.

To avoid extensive purging for soil gas samples collected at less than five feet bgs, a default of three purge volumes should be extracted prior to sampling. If VOCs are not detected in any of the step purge tests, a default of three purge volumes should be used.

Include the purge test data in the report to support the purge volume selection. The data set should include the purge volume test as well as the flow rate, vacuum exerted on the formation, and duration of each purge step. Additionally, dependent on the objectives of the characterization activities, collecting pneumatic data during the purge

## ADVISORY – ACTIVE SOIL GAS INVESTIGATIONS

volume testing may be warranted to determine the air permeability of the subsurface (see Appendix D for more information).

### 4.2.4 Additional Purge Volume Tests

Additional purge volume tests may be warranted by site-specific situations. Under the following conditions, additional purge volume tests should be conducted:

- A previously unknown lithology is encountered;
- Variable flow conditions are unexpectedly encountered; or
- If the default purge volume of three is used and a VOC of concern not previously detected is subsequently detected.

If a new purge volume is selected, then 10 percent of the previously completed soil gas wells should be re-sampled using the new purge volume. Re-sampling may be necessary for all previously sampled soil gas wells depending on results of the re-sample. The soil gas investigation may then be continued with the revised purge volume in the remaining areas.

### 4.3 PURGE/SAMPLE FLOW RATE AND APPLIED VACUUM

Flow rates between 100 to 200 milliliters per minute (mL/min) and vacuums less than 100 inches of water should be maintained during purging and sampling to minimize stripping (partitioning of vapors from pore water to soil gas), to prevent ambient air from diluting the soil gas samples, and to reduce variability between contractors. Maintaining these flow rates and vacuums will increase the likelihood that representative samples will be collected. A flow rate greater than 200 mL/min may be used when purging times are excessive, such as for deep wells with larger-diameter tubing. However, a vacuum of 100 inches of water or less must be maintained during sampling whenever a higher flow rate is used. The pressure gauge used to measure vacuum should be calibrated and in good working order.

A vacuum gauge should be used between the soil gas sample tubing and the soil gas purging device to verify that 100 inches of water or less is maintained during sampling. Gas-tight syringes may also be used to qualitatively determine if a high vacuum soil condition is present. If a high vacuum condition is present due to low permeability soil, the sampling technician can feel the suction while the plunger on the syringe is being withdrawn. If low permeability conditions are encountered where 100 inches of water is exceeded, the well can be sampled using the techniques in Appendix D (Soil Gas Sampling in Low Permeability Soil).

#### 4.3.1 Vacuum Pump

When a vacuum pump is used, collect samples on the intake side to prevent potential contamination from the internal parts of the pump. To collect the sample in a polymer gas sampling bag, a lung box<sup>5</sup> is required. Record the vacuum readings and

---

<sup>5</sup> A lung box is a small airtight chamber into which the polymer gas sampling bag is placed. The connective tubing to the bag protrudes out a hole in the chamber. The sealed chamber is evacuated by a pump, causing the bag to

## **ADVISORY – ACTIVE SOIL GAS INVESTIGATIONS**

corresponding flow rates on field data sheets for each sample. If the pump is battery-operated, the batteries should be checked before and during the operation to ensure that a proper charge is maintained. As batteries lose charge the flow rate is lowered, effectively changing the purge rate.

## 5.0 SAMPLE HANDLING AND TRANSPORT

### 5.1 SAMPLE CONTAINERS

Collect samples in gas-tight containers and handle in a manner that will prevent photodegradation of the target analytes. Sample containers should not compromise the integrity of the samples.

#### 5.1.1 Syringes

Syringes should be checked for leaks before each use by closing the exit valve and attempting to force ambient air through the needle. Gas-tight glass syringes with Teflon<sup>®</sup> seals are preferred. Glass syringes should be leak tested periodically to verify integrity with age.

Plastic syringes should not be used because of the potential interaction with some target analytes.

#### 5.1.2 Passivated Stainless Steel Canisters

Passivated stainless steel canisters need a flow regulator and vacuum gauge when sampling soil gas. If the canister is not fitted with a permanent vacuum gauge, a field vacuum gauge should be attached between the flow regulator and the canister inlet during sampling. To prevent stripping, connections should be initially hand-tightened. To verify the integrity of the seal on the steel canisters during transit, pressure readings should be collected during the canister's journey. The stationary laboratory should record the pressure when the canisters leave the laboratory and record it again on receipt of the canisters. Likewise, the field crew should record the pressure upon start and completion of the sampling. Typically, canisters are returned to the stationary laboratory with a slight vacuum (two to four inches of mercury). These pressure measurements should be included in the laboratory's analytical report as a mechanism to verify the integrity of the sample.

Pressure measurements should be collected using a calibrated pressure gauge, using the same gauge at the laboratory and in the field. Field crews should only rely on canister-dedicated pressure gauges if the gauges are calibrated and working properly. Canister-dedicated gauges tend to be inaccurate due to overuse.

#### 5.1.3 Polymer Gas Sampling Bags or Glass Bulbs

Samples in polymer gas sampling bags or glass bulbs should be analyzed within six hours after collection. Appendix B discusses the merits of collecting samples in polymer gas sampling bags.

Surrogates do not need to be added to polymer gas sampling bags because surrogate recovery levels cannot be precisely calculated since the volume of soil gas collected in a polymer gas sampling bag cannot be measured precisely. Thus, adding surrogates to polymer gas sampling bags is unnecessary.

## **ADVISORY – ACTIVE SOIL GAS INVESTIGATIONS**

Samples collected in glass bulbs should have surrogates added within 15 minutes of collection and the samples analyzed within six hours after collection.

### **5.1.4 Sorbent Tubes**

Sorbent tubes are used with USEPA (1999) Compendium Method TO-17 (Method TO-17). Method TO-17 describes:

- Sorbent tube sampling procedures;
- Sorbent tube selection;
- Tube conditioning;
- Sampling apparatus;
- Sampling rates;
- Sample collection preparation;
- Flow rates; and
- Other sampling procedures.

Method TO-17 is used for VOCs and SVOCs including naphthalene (See Appendix E for additional details on collecting and analyzing for naphthalene in soil gas).

### **5.1.5 Alternate Sample Containers**

Non-traditional sample containers are available for collecting soil gas samples. MiniCans, smaller versions of the passivated stainless steel canister, may be useful in many field applications. Evacuated glass bottles (e.g., Bottle Vac®) may also be used but their holding time should be limited to 48-hours. The use of non-traditional size or types of containers should be discussed in the workplan.

## **5.2 FIELD CONDITIONS**

The regulating agency may request raw data at any time during the investigation. Hard copies of the complete raw laboratory data, including handwritten field and laboratory notes, should be provided to the regulating agency staff upon request. Adjustments or modifications to the sampling program may be required by the regulating agency to accommodate changes mandated by evaluation of the data set or unforeseen site conditions. Field conditions, such as rainfall, irrigation, low permeability lithology or drilling conditions may affect the ability to collect soil gas samples.

### **5.2.1 Rainfall and Barometric Pressure (See Appendix G)**

Rainfall decreases the air-filled porosity of the shallow soil, thereby limiting diffusional transport of volatile contaminants. Also, soil gas contaminants may partition into the clean infiltrating rainwater, both of which may potentially bias soil gas sampling results. Hence, soil gas sampling should not occur during a significant rain event and should only occur after five days without a significant rain event. A significant rain event is defined as 1/2 inch or greater of rainfall during a 24-hour period. The waiting period is based upon soil drainage curves. Appendix G provides additional information. Irrigation or watering of soil should stop at least five days prior to the soil gas sampling event. Likewise, areas subject to soil gas sampling should be free of standing or ponded water



## ADVISORY – ACTIVE SOIL GAS INVESTIGATIONS

for at least five days prior to sampling. Do not perform soil gas sampling in swales or depressions where water might have accumulated. However, soil gas sampling after rainfall can proceed where infiltration has not occurred, such as under buildings or beneath high-integrity pavement.

Barometric pressure fluctuations associated with the passage of frontal systems can introduce atmospheric air into the shallow vadose zone. Therefore, soil gas sampling should be delayed until frontal systems have passed the area.

### 5.2.2 Wet Conditions

If no flow or low flow conditions are encountered where water is drawn into the sampling system due to wet soils caused by rain or irrigation, cease soil gas sampling and wait five days for the soils to drain.

### 5.2.3 Soil Gas Sampling in Low-Permeability Soil

Soil gas sampling in silt and clay-rich soils is feasible by following the sampling protocols described in Appendix D. Low flow or no flow conditions correspond to conditions where the minimum flow rate of 100 mL/min cannot be sustained at the maximum applied vacuum of 100 inches of water. High quality data can be produced by implementing the following field practices:

- Good annular seals;
- Careful monitoring of flow rate and vacuum during purging; and
- Use of tracer gas for leak-testing.

If the soil gas permeability is too low to allow sustainable purging at appreciable flow rates without applying excessive vacuum, follow the protocols described in Appendix D by using an alternative sample collection method or re-drilling and constructing a soil gas well in a non-traditional manner.

If low flow or no flow conditions are encountered, a new soil gas well in a coarser lithology at a different depth or lateral location may be installed. The following should be considered if low-flow conditions persist:

- 1) Evaluate site lithologic logs and adjust sample depth and location;
- 2) Collect new continuous soil core samples;
- 3) Use alternate low-flow sampling methods (see Appendix D);
- 4) Use passive soil gas methods (see Appendix A); and
- 5) Collect soil matrix VOC samples using 5035/8260 (DTSC, 2004).

If moisture or unknown material is observed in the sample container, cease soil gas sampling until the cause of the problem is determined and corrected. Moisture detected in either the sampling train or the sample container may indicate saturated conditions in the subsurface. Vapor phase compounds may partition into the dissolved phase, affecting the recovery of target analytes and causing analytical results to be biased low.

### **5.2.4 Drilling Refusal**

If refusal occurs during drilling, soil gas samples should be collected as follows:

- 1) Install a replacement borehole at least five feet laterally from the original boring location. If refusal still occurs after three tries, collect a soil gas sample at the depth of refusal or use an alternate drilling method; and
- 2) If refusal occurs at depths less than five feet, collect the soil gas sample following the precautions in Appendix D. Sealing off the probe to ambient air is critical to obtaining high quality data.

## **5.3 SAMPLE CONTAINER HANDLING**

Sample handling procedures cited in the analytical methods should be followed. However, since most methods are not designed for soil gas, additional safeguards should be implemented to maintain the integrity of the samples. If samples need to be shipped to a stationary laboratory, then follow the container-specific handling procedures below.

### **5.3.1 Syringes and Glass Bulbs**

Samples in syringes and glass bulbs should be analyzed as soon as possible after collection in a mobile laboratory and should never be transported. Samples in syringes and glass bulbs should be kept in a cool dark location at all times, protected from exposure to light, until the samples are analyzed. A cooler without ice works well for syringe and glass bulb sample storage.

Do not subject syringe and glass bulb samples to extreme temperatures. Heat can cause compound degradation and leakage from the syringe or glass bulb. Cold can cause moisture condensation, which can affect the recovery of target analytes. If condensation is observed, the sample should be discarded and a new sample should be collected.

### **5.3.2 Sorbent Tubes**

Samples collected in sorbent tubes may be shipped for analysis at a stationary laboratory. Samples tubes should be capped with Swagelok<sup>®</sup>-type caps and combined Teflon (PTFE) ferrules, rewrapped in aluminum foil, and placed in the storage container immediately after sampling.

## **ADVISORY – ACTIVE SOIL GAS INVESTIGATIONS**

Sorbent tubes should be stored at 4°C or less and analyzed within 30 days after collection. For compounds likely to undergo chemical degradation, such as bis-chloromethyl ether and sulfur or nitrogen-containing volatiles, analysis should be done within one week (USEPA, 1999; Compendium Method TO-17, Section 10.10).

Samples collected on tubes containing multiple sorbent beds should be analyzed as soon as possible after collection unless it can be verified that storage will not affect analyte recovery (USEPA, 1999; Compendium Method TO-17, Section 10.10).

### **5.3.3 Polymer Gas Sampling Bags**

These procedures should be followed when transporting samples in polymer gas sampling bags:

- 1) Do not expose soil gas samples in polymer gas sampling bags to light or extreme temperatures. Photodegradation of target analytes is possible with light exposure. Heat can cause expansion of the bag and possibly result in leakage. Cold can cause moisture condensation in the bags;
- 2) Do not ship polymer gas sampling bags by air because changes in ambient pressure can adversely affect the integrity of the bags. Increases in pressure may collapse the bag and decreases in pressure may expand the bag. These changes in pressures, coupled with possible flaws in the bag, may cause sample loss; and
- 3) Do not ship polymer gas sampling bags by vehicle where changes in elevation, such as over mountain passes, will result in ambient pressure changes.

### **5.3.4 Passivated Stainless Steel Canisters**

Samples collected in passivated stainless steel canisters may be shipped for analysis at a stationary laboratory. Passivated stainless steel canisters have minimal problems associated with their handling. Therefore, no additional precautions or safeguards are needed.

## **5.4 SAMPLE CONTAINER CLEANLINESS AND DECONTAMINATION**

New containers should be shown to be free of contaminants by providing data from either the supplier or the analytical laboratory. After each use, reusable sample containers should be decontaminated as follows:

- 1) Glass syringes and bulbs may be decontaminated by disassembling and heating them. Some components of the syringes and glass bulbs, such as the syringe barrel and bulb stopcock, cannot be heated and should be decontaminated by other methods such as rinsing with methanol and/or expunging with nitrogen or clean air. If a syringe is reused, it should be blank tested, and tested for adsorptive losses via spike testing;

## **ADVISORY – ACTIVE SOIL GAS INVESTIGATIONS**

- 2) Passivated stainless steel canisters should be decontaminated as specified in USEPA Method TO-15, either batch or individually certified, according to project DQOs;
- 3) Polymer gas sampling bags should not be reused; and
- 4) Equipment blanks should be analyzed to verify and evaluate the effectiveness of decontamination procedures for recycled or reused containers, except for certified containers. At a minimum, one equipment blank should be run per 20 sample containers cleaned, or at least one per day.

### **5.5 CHAIN OF CUSTODY RECORDS**

The chain of custody documents the identity and integrity of the sample from the time of collection through receipt at the laboratory.

A chain of custody form should be completed in the field and include any relevant problems encountered during sample collection. The starting and ending pressures for passivated stainless steel canisters should be recorded on the chain of custody form. USEPA provides a complete description of chain of custody protocols and records management (USEPA, 1998, 2000b). To avoid loss or damage, the chain of custody forms should be placed into a sealable bag and attached to the inside of the shipping container.

## 6.0 ANALYSIS OF SOIL GAS SAMPLES

The sections below summarize analytical methods, QA/QC, holding times, reporting and laboratory certification. Additional details are provided in Appendices F and H.

### 6.1 TARGET COMPOUNDS

Target compounds are chemicals believed to be present, used, or released at the site. Common target compounds are listed below. Compounds may be added or excluded from the list below based on site history and DQOs. A vapor intrusion-specific list can be found in DTSC's Vapor Intrusion Guidance (DTSC, 2011).

#### 6.1.1 Common Organic Compounds

##### Halogenated

- 1) Bromochloromethane
- 2) Bromodichloromethane
- 3) Bromomethane
- 4) Carbon tetrachloride
- 5) Chloroethane
- 6) Chloroform
- 7) 1,1-Dichloroethane
- 8) 1,2-Dichloroethane
- 9) 1,1-Dichloroethylene
- 10) cis-1,2-Dichloroethylene
- 11) trans-1,2-Dichloroethylene
- 12) Dichlorodifluoromethane (Freon 12)
- 13) Dichloromethane (Methylene chloride)
- 14) Tetrachloroethylene
- 15) 1,1,1,2-Tetrachloroethane
- 16) 1,1,2,2-Tetrachloroethane
- 17) 1,1,1-Trichloroethane
- 18) 1,1,2-Trichloroethane
- 19) Trichloroethylene (TCE)
- 20) Trichlorofluoromethane (Freon 11)
- 21) 1,1,2-Trichloro-1,2,2-trifluoroethane (Freon 113)
- 22) Vinyl chloride

##### Aromatics and Oxygenates

- 23) Benzene
- 24) n-Butylbenzene
- 25) sec-Butylbenzene
- 26) tert-Butylbenzene
- 27) 1,4-Dichlorobenzene
- 28) Di-isopropyl ether (DIPE)
- 29) Ethylbenzene
- 30) Ethyl tertiary butyl ether

## ADVISORY – ACTIVE SOIL GAS INVESTIGATIONS

- 31) Isopropylbenzene
- 32) p-Isopropyltoluene
- 33) Methyl tertiary butyl ether (MTBE)
- 34) Naphthalene
- 35) n-Propylbenzene
- 36) Tertiary amyl methyl ether
- 37) Tertiary butyl alcohol
- 38) Toluene
- 39) 1,2,4-Trichlorobenzene
- 40) 1,2,4-Trimethylbenzene
- 41) 1,3,5-Trimethylbenzene
- 42) Xylenes

### Others

- 43) Acetone
- 44) Carbon disulfide
- 45) 2-Hexanone
- 46) Styrene
- 47) Methyl ethyl ketone
- 48) Methyl isobutyl ketone
- 49) Ethylene dibromide

## 6.2 REPORTING LIMITS FOR TARGET COMPOUNDS

Reporting limits (RLs) should be based on the DQOs of the investigation. Corresponding analytical methods should be selected to achieve RLs that are below regulatory or risk-based screening levels. The RLs for the leak check compound should be reported at the RL of the target analytes.

When RLs are elevated due to sample dilution, the laboratory should provide a written explanation of why the project-specific RLs were not achieved. In some instances, sample dilution is necessary because of high concentrations of non-target compounds (background). It may be necessary to collect new samples for reanalysis to achieve appropriate RLs pursuant to the project's DQOs. A higher RL as a result of sample dilution is acceptable for the compound(s) whose concentration in an undiluted sample exceeds the upper level of an initial calibration range. Non-detected results for all target compounds shall be reported at the lowest dilution(s) concentration or no dilution concentration.

## 6.3 QUALITY ASSURANCE/QUALITY CONTROL

This section primarily focuses on field laboratory QA/QC and not stationary laboratory QA/QC. For a detailed discussion on stationary laboratory QA/QC, refer to Appendix F.

Laboratories should comply with the project QAPP, USEPA Methods, and the criteria in this Advisory. The analytical data should be consistent with the DQOs established for the project.

## **ADVISORY – ACTIVE SOIL GAS INVESTIGATIONS**

The regulating agency may inspect the field and/or stationary laboratory QA/QC procedures. Copies of the QA/QC plan and laboratory calibration data should be presented upon request.

All calibration and QA/QC standards, traceable to a source, should be documented by the laboratory. Continuing calibration and QC standards should be from a second source or a different lot from the same supplier. Vapor phase standards should be used to calibrate laboratory instruments.

The following items should be included when using USEPA Methods:

- Initial calibration;
- Daily calibration/continuing calibration;
- Laboratory control spike;
- Internal standards;
- Surrogates;
- Method blank; and
- Field blank.

All surrogate recovery data should comply with laboratory-derived control limits. Control limits should be listed in the laboratory reports for reference.

Surrogate recovery limits should be approximately 70 percent to 130 percent (30 percent deviation). The laboratory-derived recovery limits may be wider or narrower than the 30 percent figure depending on sample introduction technique and compound used. If a compound-specific recovery limit is not selected, an explanation should be provided to justify the recovery limit used. See Appendix F for surrogate introduction techniques.

### **6.3.1 Sample Blanks**

- **Method Blanks:** Method blanks should be used to verify the effectiveness of decontamination procedures in the laboratory, and to detect any possible interference from ambient air;
- **Trip Blanks for Off-site Shipments:** Trip blanks should be included in the shipping containers when collecting USEPA TO-17 samples;
- **Material Blanks:** Prior to soil gas sampling, an assembled soil gas probe, tip and tubing should be blank tested at a frequency of one analysis per new batch of tubing or material used; and
- **Equipment Blanks:** Equipment blanks should be collected from decontaminated equipment before reuse at a frequency specified in the workplan. One equipment blank should be collected and analyzed for each batch of 20 samples, or at least one per day, whichever is more often.

### **6.3.2 Field Duplicate/Replicate Samples**

Duplicate samples are collected simultaneously, whereas replicate samples are collected sequentially. At least one duplicate/replicate sample should be collected and analyzed per 20 samples or per batch, whichever is more often.

Duplicate/replicate samples should be collected from contaminated areas at a frequency based on the project DQOs. The workplan should state the duplicate/replicate collection frequency.

Duplicate/replicate samples should be collected in separate sample containers at the same location and depth. Replicate samples can be collected immediately after the original sample, or a duplicate sample can be collected simultaneously by use of a T-splitter at the point of collection to divide the sample stream into two separate sample containers.

The field replicate mentioned in this section should not be confused with the laboratory replicate (see Table 2 in Section 6.5, and the QA/QC Section of Appendix F).

When comparing the results from field duplicate/replicate samples, a wider allowance should be given for the differences (e.g., 50 percent Relative Percent Difference [RPD]) because of the inherent variability associated with soil gas samples. The specific guideline for the RPD should be based on DQOs and be specified in the QAPP.

### **6.3.3 Laboratory Control Samples**

Laboratory Control Samples (LCS) are optional as described in Appendix F.

### **6.3.4 Split Samples**

The regulating agency may request split samples be collected and analyzed by a separate laboratory.



## 6.4 HOLDING TIMES

Holding times for soil gas samples should be specified in the workplan. All soil gas samples should be analyzed pursuant to container-specific holding times, as follows:

**TABLE 1**  
**Soil Gas Sample Holding Time**

Container	Holding Time	Comments
Glass syringes	30 minutes	
Polymer gas sampling bags	6 hours	
Glass bulbs	24 hours	Must have surrogate added within 15 minutes of collection
Passivated stainless steel canisters	30 days	
Sorbent Tubes	30 days	Sulfur and nitrogen compounds and bis-chloromethyl ether should be analyzed with one week.
Hydrogen sulfide	See Section 7.1	

Note that for passivated stainless steel canisters, storage pressure and humidity in a canister are also important factors that determine analyte recovery. Additionally, mercaptans, dimethyl acetal and bis-[chloromomethyl] ether at low concentrations are not suitable for collection in passivated canisters pursuant to a study by Brymer and others (1996).

## 6.5 ANALYTICAL METHODS

There are no approved USEPA methods specifically designed to analyze soil gas samples. Consequently, modified versions of existing USEPA methods were adopted.

Numerous modifications of USEPA methods are being used for soil gas analysis. Each modification has advantages and disadvantages. Soil gas analysis should be performed in accordance with the protocols noted in the respective USEPA method(s) concurrently with the specific recommended practices for soil gas samples outlined in Table 2. Methods/Parameters not included in Table 2 should be followed as stated in the original USEPA method.

For a more detailed discussion on the various types of modifications and other applications, consult Appendix F.

**TABLE 2**  
**Preferred Analytical Methods and Modifications\***

Method/ Parameter	GC/MS Methods			GC Methods	COMMENTS
	Modified USEPA 8260	Modified USEPA TO-15	Modified USEPA TO-17	Modified USEPA 8015 and Modified USEPA 8021	
<b>Applicability/Analytes</b>	Most VOCs: confirmation sampling for naphthalene should be performed by USEPA TO-17.	Most VOCs: confirmation sampling for naphthalene should be performed by USEPA TO-17.	Most VOCs: approximate concentrations should be known prior to sampling.	Limited number of VOCs: gasoline/TPH most VOCs: confirmation sampling for naphthalene should be performed by USEPA TO-17.	See Appendix F of this guidance for discussion.
<b>Sample Introduction Technique</b>	Modified Purge-and-trap (USEPA 5030).	Samples collected in passivated canisters: VOCs are concentrated on sorbent trap.	Samples pulled through sorbent pack, thermally desorbed into GC.	Modified purge-and-trap (USEPA 5030).	See Appendix F of this guidance for discussion.
<b>Sample Size</b>	Purge-and-trap: 5 to 250 mL (cc) (See Appendix F for discussion).	To be determined by sample delivery technique and sample concentration; typically 1 to 6 liters.	To be determined by a combination of factors: sorbent selected, tube length, humidity, temperature; 50 to 250 ml of sample suggested.	Purge-and-trap: 5 to 250 mL (cc) (See Appendix F for discussion).	See Appendix F of this guidance for discussion.  Dilution may be needed if high concentration is suspected.
<b>Method Validation <sup>(1)</sup></b>	As per Section 8.4 of USEPA 8000B.	As per Section 8.4 of USEPA 8000B.	As per Section 8.4 of USEPA 8000B.	As per Section 8.4 of USEPA 8000B.	
<b>Initial Calibration</b>	Minimum of 5 levels, lowest at reporting level. Use method acceptance criteria.	Minimum of 5 levels, lowest at reporting level. Use method acceptance criteria.	Minimum of 5 levels, lowest at reporting level. Use method acceptance criteria. Preloaded certified standard tubes may be used for calibration.	Minimum of 5 levels, lowest at reporting level. Use method acceptance criteria.	Vapor-phase standards are preferred. Liquid standards may be used for USEPA Methods 8260, 8015, 8021 and TO-17 provided calibration curve is validated. See Appendix F of this guidance.
<b>Continuing Calibration</b>	Mid-level calibration standard run every 12 hours. Use method acceptance criteria.	Mid-level calibration standard run every 24 hours. Use method acceptance criteria.	Mid-level calibration standard every 10 sample batch (Section 12 of USEPA TO-17).	Mid-level calibration standard run every 12 hours. Use method acceptance criteria.	
<b>Calibration Validation</b>	At minimum, vapor-phase validation check standard <sup>(2)</sup> analyzed and evaluated for each new calibration curve (% difference ≤ 20%).	Not Applicable.	No vapor-phase standard validation needed for liquid standards.	At minimum, vapor-phase validation check standard <sup>(2)</sup> analyzed and evaluated for each new calibration curve (% difference ≤ 20%).	Validation not needed if calibration curve is prepared with vapor-phase standards.

**TABLE 2 (continued)  
Preferred Analytical Methods and Modifications\***

Method/ Parameter	GC/MS Methods			GC Methods	COMMENTS
	Modified USEPA 8260	Modified USEPA TO-15	Modified USEPA TO-17	Modified USEPA 8015 and Modified USEPA 8021	
<b>End of Run Calibration Check</b>	Optional.	Optional.	Optional.	Mid-level calibration standard run for each 20 sample batch or at end of run, whichever is more often.	See Appendix F of this guidance for discussion.
<b>Surrogates</b>	Surrogates needed for glass bulbs but not for syringes or polymer sampling bags.	Optional.	Optional.	<b>8015:</b> To be determined by lab. <sup>(3)</sup> <b>8021:</b> Surrogates needed for glass bulbs but not for syringes or polymer sampling bags.	Recovery acceptance limits to be determined by lab. Default=70-130%.
<b>Internal Standards</b>	As per Section 5.10 of USEPA 8260.	As per Section 9.2.2.3 of USEPA TO-15.	As per Sections 6.12.2 and 9.4 of USEPA TO-17.	<b>8015:</b> To be determined by lab. <sup>(3)</sup> <b>8021:</b> As per Section 5.9 of USEPA 8021.	
<b>Accuracy/Precision Matrix Spike/Matrix Spike Duplicate</b>	See Appendix F of this guidance.	Optional.	Optional.	See Appendix F of this guidance.	See Appendix F of this guidance for discussion. Recovery acceptance limits to be determined by lab. Default=70-130% and %RPD=25%.
<b>Duplicates</b>	One per 20 samples or batch, whichever is more often.	One per 20 samples or batch, whichever is more often.	One per 20 samples or batch, whichever is more often.	One per 20 samples or batch, whichever is more often.	See Appendix F of this guidance for discussion. %RPD=25%.
<b>Replicates</b>	One per 20 samples or batch, whichever is more often.	One per 20 samples or batch, whichever is more often.	One per 20 samples or batch, whichever is more often.	One per 20 samples or batch, whichever is more often.	See Appendix F of this guidance for discussion. %RPD=25%.
<b>Laboratory Control Samples (LCS)</b>	Optional.	Not Required.	Not Required.	Optional.	See Appendix F of this guidance for discussion.
<b>Method Detection Limit/Reporting Limit</b>	See Appendix F of this guidance.	See Appendix F of this guidance.	See Appendix F of this guidance.	See Appendix F of this guidance.	See Appendix F of this guidance.
<b>Reporting Limit Verification</b>	One per batch of samples. <sup>(4)</sup>	One per batch of samples. <sup>(4)</sup>	One per batch of samples. <sup>(4)</sup>	One per batch of samples. <sup>(4)</sup>	See Appendix F of this guidance for discussion.
<b>Method Blanks</b>	Method blank using humidified lab grade ultra-pure air as sample and per Section 8.4.1 of USEPA 8260.	Analyze at least once in a 24-hour analytical sequence.	At least two are required per monitoring exercise.	<b>8015:</b> Method blank using humidified lab grade ultra-pure air as sample and per Section 9.5 of USEPA 8015C. <b>8021:</b> Per Section 8.4 of USEPA 8021.	

**TABLE 2 (continued)  
Preferred Analytical Methods and Modifications\***

Method/ Parameter	GC/MS Methods			GC Methods	COMMENTS
	Modified USEPA 8260	Modified USEPA TO-15	Modified USEPA TO-17	Modified USEPA 8015 and Modified USEPA 8021	
<b>Container Blank</b>	One sample container per 20 samples or per batch, whichever is more often.	One sample container per 20 samples or per batch, whichever is more often.	One sorbent tube blank per 20 samples or per batch, whichever is more often.	One sample container per 20 samples or per batch, whichever is more often.	Monitor other components (i.e., fittings/ valves) of sampling system if needed.
<b>Holding Time</b>	Analyze syringes within 30 minutes of collection; analyze glass bulbs within 24 hours following surrogate addition; analyze passivated stainless steel canisters within 30 days; analyze polymer gas sampling bags within 6 hours.	Analyze passivated stainless canisters within 30 days; sulfur and nitrogen compounds and bis-chloromethyl ether should be analyzed within one week.	Up to 30 days refrigerated. Exceptions as noted in Section 10.10 of USEPA TO-17.	Analyze syringes within 30 minutes of collection; analyze glass bulbs within 24 hours following surrogate addition; analyze passivated stainless steel canisters within 30 days; analyze polymer gas sampling bags within 6 hours.	
<b>Other Requirements</b>	Tuning: 50 ng Bromofluorobenzene (BFB) initially and every 12 hours. Meet acceptance criteria as per Table 4 of USEPA 8260.	1. Tuning: 50 ng BFB initially and every 24 hours. Meet acceptance criteria as per Table 3 of USEPA TO-15.  2. Must meet equipment specifications in Section 7.2 of USEPA TO-15 or report results as modified TO-15.	1. Analytical protocol as per USEPA TO-15. 2. Condition freshly packed (new) sorbent tubes. 3. Collect and analyze "Distributed Volume Pairs" for uncharacterized sites as per Section 10.7 of USEPA TO-17. 4. Determine/ validate "Safe Sampling Volume" (SSV) if needed as per Sections 10.8 and 13.1.2 of USEPA TO-17; analyze as per USEPA TO-15 and Section 11.2 of USEPA TO-17. 5. Analytical precision test as per Section 11.3.2.2 of USEPA TO-17. 6. Performance criteria as per Section 14 of USEPA TO-17.	Use only for routine monitoring at well-characterized sites. Other than TPH, identification of new compounds must be confirmed either by second column or different detector, and then 10% of those samples must be confirmed with a GC/MS method.	

\* Adapted from "Guide to Environmental Analytical Methods" 5<sup>th</sup> edition, Edited by Roy-Keith Smith, Ph.D., Genium Publishing Corp., 2003.

<sup>(1)</sup> Initial, one-time demonstration of ability to generate acceptable accuracy and precision. Procedure may need to be repeated if changes in instrument, methodology or personnel occur. USEPA Method 8000B (Determinative Chromatographic Separations), Revision 2, December 1996 (SW-846 Manual).

<sup>(2)</sup> Mid-level NIST (National Institute of Standard and Technology) traceable (where available or equivalent) vapor-phase standard.

<sup>(3)</sup> No internal standards and surrogates were suggested by the method. The compounds are to be selected by the laboratory analyst and they must be similar in analytical behavior to the compounds of interest. The analyst needs to demonstrate the internal standards are not affected by method or matrix interferences.

<sup>(4)</sup> There is no limit on the number of samples per batch for Reporting Limit Verification. If the RL is set at the lowest calibration point, then this verification is not needed.

## **6.6 SOIL GAS SAMPLE ANALYSIS AND LABORATORY REPORTING**

### **6.6.1 Analytical Methods**

At sites that are not fully characterized, soil gas samples should be analyzed using only USEPA modified analytical methods 8260B, TO-15, TO-17, or equivalent. At well-characterized sites, alternative methods may be used for monitoring contamination where VOCs are known to be present and confirmed based on previous gas chromatograph/ mass spectrometer (GC/MS) analyses. Non-specific portable organic vapor analyzers and/or GC-based hand-held detectors can provide useful information for selecting samples for laboratory analysis and verifying the integrity of collected samples. However, these instruments are not acceptable substitutes for compound-specific analysis due to a lack of QA/QC protocols. The various available VOC analytical methods are discussed in detail in Appendix F. Additional discussion is provided in Appendix E specific to soil gas containing naphthalene.

If new VOC(s) are detected by a non-GC/MS method during routine monitoring, then at least 10 percent of the samples for each newly identified VOC should be confirmed by a GC/MS method. Thereafter, routine monitoring can resume with the non-GC/MS method, including the newly identified analyte(s).

### **6.6.2 Contaminant Reporting**

Laboratory reports should contain the analytical results for all identified quantifiable contaminants, along with all tentatively identified compounds (TICs) with an estimated concentration. The site's QAPP should specify that TICs will be identified and reported.

### **6.6.3 Leak Check Compounds**

Liquid and gaseous leak check compounds should be included in the laboratory analyte list. The laboratory reports should quantify and annotate all detections of the leak check compound the target analyte reporting limits. For additional information on leak check compounds, refer to Section 4.2.

### **6.6.4 Auto Samplers**

Using an autosampler with modified USEPA Method 8260B/C for soil gas analysis is not reliable. Sample loss may occur from the vials during the sample transfer and sample run. In addition, the vials may sit in the autosampler for an extended period of time which may compromise the sample through leakage at the vial seal (See Appendix F, GC/MS Methods Section for additional information).

## 7.0 METHANE AND HYDROGEN SULFIDE SAMPLING PROGRAMS

### 7.1 METHANE

There are several analytical methods appropriate for methane, including:

- USEPA Methods 8015B modified;
- TO-3, 3C;
- ASTM Method D1945; or
- ASTM Method D1946.

Methane may also be measured with a hand held gas emissions monitor or analyzer. The RLs for methane analysis should be determined by project-specific DQOs.

#### 7.1.1 Methane Field Collection

The following procedures should be followed when collecting samples for methane analysis:

- Methane should be collected in gas-tight sample containers such as passivated stainless steel canisters or polymer gas sampling bags.
- Fixed and biogenic gases such as oxygen, carbon dioxide, methane and ethylene should be analyzed to determine whether methanogenesis is occurring. The RL for oxygen and carbon dioxide should be one percent or less.
- Prior to sampling, tubing or probe pressure should be recorded in the field logs and reported along with the methane concentration to determine if the area is pressurized.

#### 7.1.2 Methane Laboratory Analysis

GC calibration curves for analytes such as methane should be recorded and reported. Hand-held instruments should be calibrated in accordance with the manufacturer's specifications. At least 10 percent of all positive detections with concentrations more than 5,000 parts per million by volume (ppmv) should be confirmed by another hand-held instrument (either different unit or a different brand) or by a GC method when a hand-held instrument is used.

### 7.2 HYDROGEN SULFIDE

Hydrogen sulfide may be analyzed using:

- South Coast Air Quality Management District Method 307-91;
- ASTM D5504;
- USEPA Method 16;
- Draeger™ tubes; or
- Other equivalent methods.

## ADVISORY – ACTIVE SOIL GAS INVESTIGATIONS

Hand held multi-gas monitors equipped with a hydrogen sulfide sensor may also be used. The RL should be equal to or less than 0.5 ppmv, be at least one microgram per liter or sensitive enough to allow for a modeled ambient air concentration at the soil surface.

### 7.2.1 Sample Containers

The following sample containers are recommended for hydrogen sulfide:

- Black polymer gas sampling bags fitted with polypropylene valves or equivalent. Clear polymer gas sampling bags can be used, stored and/or transported provided they are protected from light;
- 100 mL gas-tight glass syringe or gas-tight glass bulb fitted with an inert valve and wrapped in aluminum foil; and
- Passivated stainless steel canister. Note that recovery of hydrogen sulfide in passivated stainless steel canisters will deteriorate naturally with time with repeated hydrogen sulfide sampling.

### 7.2.2 Hydrogen Sulfide Field Collection

Hydrogen sulfide samples should be analyzed by a hand-held instrument within 30 minutes of collection to minimize sample degradation from reaction with the container surfaces. If a hand-held instrument is not used, hydrogen sulfide samples should be analyzed as follows:

- 1) Within 30 minutes of collection using GC procedures;
- 2) Within 24 hours of collection if duplicate samples are collected and analyzed; or
- 3) Within 24 hours of collection in polymer gas sampling bag using ASTM D5504 with no surrogate addition needed.

### 7.2.3 Precautions Particular to Hydrogen Sulfide

- 1) Contact with oxygen and moisture should be avoided because hydrogen sulfide is extremely unstable;
- 2) Due to the high reactivity of hydrogen sulfide gas, avoid contact of hydrogen sulfide samples with metallic or other active surfaces during sample collection, storage, and analysis;
- 3) Ensure GC components do not react with the sample. Typically, glass-lined injection ports, thick-film capillary columns and silcosteel<sup>®</sup> lined tubing are used to avoid loss of hydrogen sulfide during analysis;
- 4) Exposure of samples to light should be minimized to prevent photodegradation; and

## **ADVISORY – ACTIVE SOIL GAS INVESTIGATIONS**

- 5) USEPA Method 16 should be used with caution because it is a source-testing method which has limitations, including non-linear detector response, high reporting limits and susceptibility to hydrocarbon interference.



## **8.0 LABORATORY CERTIFICATION**

The California Department of Public Health, Environmental Laboratory Accreditation Program (ELAP), offers certification for soil gas analysis. Laboratories utilizing USEPA Methods 8015B, 8021B, 8260B, TO-15 and TO-17 for analyses of soil gas samples should obtain ELAP certifications for these methods. Accreditation under National Environmental Laboratory Accreditation Program (NELAP) for USEPA Methods TO-13A, TO-15 and TO-17 for ambient air testing is acceptable as certification for soil gas testing.

As of the date of this document, the development of a laboratory certification program for soil gas is in progress in California. Once a certification program is available by the California Department of Public Health, laboratories should apply to be certified. Further information concerning laboratory certification is provided in Appendix F.

Any laboratory analyzing soil gas samples may be subject to inspection by regulatory agency staff.

## 9.0 REFERENCES

- Abreu, L.D.V., and P.C. Johnson. 2005. *Effect of Vapor Source – Building Separation and Building Construction on Soil Vapor Intrusion as Studied with a Three-Dimensional Numerical Model*, Environmental Science and Technology, v. 39, no. 12, p. 4550-4561.
- Abreu, L., P.C. Johnson, and T. McAlary. 2006. *3D Model Simulations and Implications to Near Building Sampling*, AEHS Vapor Intrusion Workshop, San Diego, California, March 16, 2006.
- Banikowski, J. E., S. W. Kaczmar, and J. F. Hunt. 2009. *Field Validation of Helium as a Tracer Gas During Soil Vapor Sample Collection*, Soil and Sediment Contamination, v. 18, p. 243 – 263.
- Brymer, D.A., L.S. Ogle, C.J. Jones, and D. L. Lewis. 1996. *Viability of using SUMMA® Polished Canisters for the Collection and Storage of Parts per Billion by Volume Level Volatile Organics*, Environmental Science and Technology. vol. 30, no. 1.
- California Department of Water Resources. 1991. *Final Draft Bulletin 74-90, California Well Standards Water Wells; Monitoring Wells, Cathodic Protection Wells*, Supplement to Bulletin 74-81, January 1990.
- Cal/EPA. 2003. *Advisory – Active Soil Gas Investigations*, Department of Toxic Substances Control and California Regional Water Quality Control Board, Los Angeles Region, January 28, 2003.
- CRWQCB. 1997. *Interim Guidance for Active Soil Gas Investigation*, February 25, 1997.
- CRWQCB. 2000. *General Laboratory Testing Requirements for Petroleum Hydrocarbon Impacted Sites*, June 22, 2000.
- Department of Toxic Substances Control. 1994. *Preliminary Endangerment Assessment Guidance Manual (A Guidance Manual for Evaluating Hazardous Substance Release Sites)*, California Environmental Protection Agency, January 1994. Reprinted June 1999 (update pending).
- Department of Toxic Substances Control. 2004. *Guidance Document for the Implementation of United States Environmental Protection Agency Method 5035: Methodologies for Collection, Preservation, Storage, and Preparation of Soils to be Analyzed for Volatile Organic Compounds*, California Environmental Protection Agency, November 2004.
- Department of Toxic Substances Control. 2011. *Guidance for the Evaluation and Mitigation of Subsurface Vapor Intrusion to Indoor Air (Vapor Intrusion Guidance)*, California Environmental Protection Agency. Original December 2004, Final October 2011.

## ADVISORY – ACTIVE SOIL GAS INVESTIGATIONS

- DiGiulio, D. and R. Cody. 2006. *Evaluation of the “Unconstrained Version” of the J&E Model and Comparison of Soil-Gas and Sub-Slab Air Concentrations at the Raymark Superfund Site*, AEHS Vapor Intrusion Work Shop, San Diego, California, March 16, 2006.
- Hers, I., H. Dawson, and R. Truesdale. 2006. *Testing Exterior Tier 3 Screening with Site Data*, AEHS Vapor Intrusion Work Shop, San Diego, California, March 16, 2006.
- ITRC. 2007. *Vapor Intrusion Pathway: A Practical Guideline*, VI-1, Washington D.C: Vapor Intrusion Team, Appendix D, Section D.4.7, Leak Tests, January, 2007.
- Johnson, P.C., and R.A. Ettinger. 1991. *Heuristic Model for Predicting the Intrusion of Contaminant Vapors into Buildings*, Environmental Science and Technology, v. 25, n. 8, p. 1445 – 1452.
- McAlary, T.A., P. Nicholson, H. Groenevelt, and D. Bertrand. 2009. *A Case Study of Soil-Gas Sampling in Silt and Clay-Rich (Low Permeability) Soils*, Ground Water Monitoring & Remediation, v. 29, no. 1, p. 144-152.
- Nicholson, P., D. Bertrand, and T. McAlary. 2007. *Soil Gas Sampling in Low-Permeability Soil*, Vapor Intrusion: Learning from the Challenges, Air & Waste Management Association’s Proceedings, September, 2007, Providence, Rhode Island, p. 299-310.
- Smith, Roy-Keith. 2003. *Guide to Environmental Analytical Methods*, 5<sup>th</sup> Edition, Genium Publishing Corporation, 2003.
- USEPA. 1988. *Guidance for Conducting Remedial Investigations and Feasibility Studies Under CERCLA, Interim Final*, Office of Emergency and Remedial Response, October 1988; EPA/540/G-89/004.
- USEPA. 1989. *Risk Assessment Guidance for Superfund, Volume I, Human Health Evaluation Manual (Part A), Interim Final*, Office of Emergency and Remedial Response, December 1989; EPA/540/1-89/00.
- USEPA. 1994a. *Guidance for the Data Quality Objective Process II (EPA QA/G-4)*, Office of Research and Development, September 1994; EPA/600R-96/055.
- USEPA. 1994b. *USEPA Contract Laboratory Program National Functional Guidelines for Organic Data Review*, February 1994; EPA540/R-94/012.
- USEPA. 1998. *Guidance for Quality Assurance Project Plans (QA/G-5)*, Office of Research and Development, February 1998; EPA/600/R-98/018.
- USEPA. 2000a. *Data Quality Objectives Process for Hazardous Waste Site Investigations*, January 2000; EPA/600/R-00/007.

## ADVISORY – ACTIVE SOIL GAS INVESTIGATIONS

USEPA. 2000b. *Test Methods for Evaluating Solid Waste, Physical/Chemical Methods, EPA Publication SW-846, Third Edition*, November 1986, as amended by Updates I (Jul. 1992), II (Sep. 1994), IIA (August 1993), IIB (Jan. 1995), III (Dec. 1996), IIIA (Apr. 1998), IVA (Jan. 1998) and IVB (Nov. 2000).

USEPA. 2006. *Draft Standard Operating Procedure (SOP) for Installation of Sub-Slab Vapor Probes and Sampling Using USEPA TO-15 to Support Vapor Intrusion Investigations*, Office of Research and Development, National Risk Management Research Laboratory.

## APPENDIX A PASSIVE SOIL GAS METHOD

Passive soil gas sampling consists of burying an adsorbent material into the subsurface soil and subsequently retrieving and measuring organic vapors passively amassed onto the adsorbent material. Unlike active soil gas sampling, passive soil gas sampling does not force soil gas into the sampling vessel through pumping or vacuum. Instead, as the vapors disperse from a subsurface contaminant source, the sorbent acts as a sink for the VOCs and SVOCs found in soil gas.

Passive soil gas methods provide a quantified mass value for the adsorbent material and a semi-quantitative soil gas result. In contrast to active soil gas samples, which yield concentration data in micrograms per cubic meter ( $\mu\text{g}/\text{m}^3$ ) or micrograms per liter ( $\mu\text{g}/\text{L}$ ), passive soil gas samples do not generate contaminant concentration data. For this reason, passive soil gas sampling and analysis is not applicable as a stand-alone method for determination of human exposure.

Potential uses of the passive soil gas method are as follows:

- 1) To delineate contaminant plumes, contaminant sources, and hot spots;
- 2) To identify potential preferential pathways where sewer and utility corridors provide vapor migration pathways into and around buildings. Passive methods can also identify preferential pathways resulting from lithologic variability;
- 3) To collect soil gas in areas where active soil gas samples are difficult to obtain. These areas include low-permeability lithology, high-moisture soils and shallow groundwater conditions. When the depth to groundwater is within five feet of the surface, the capillary fringe may prevent sample collection by active soil gas methods due to the high soil moisture content; and
- 4) To evaluate whether a release has occurred. Active soil gas data should be collected following the detection of subsurface contamination by the passive method.

**Advantages of the passive soil gas methods are:**

- 1) Provides a time-integrated measurement, which reduces uncertainty due to temporal variations;
- 2) Detects compounds with low vapor pressures not easily captured by active methods, such as naphthalene (see Appendix E);
- 3) Maintains subsurface equilibrium during sampling since there is no forced movement of soil gas into the sampling vessel with passive methods; and
- 4) Simple to design, install, and retrieve.

## **Passive Sampling Procedures**

Analytical procedures, deployment depths, and sampling durations will depend on the manufacturer's recommended procedures. Some samplers currently available can be installed at any depth, and at the same sampling density as the active method.

Typically, passive samplers are deployed in hand-drilled boreholes that are three to five feet deep and one-inch in diameter. The sampler is lowered into the borehole with a string and the surface is covered to prevent the introduction of ambient air. Deployment duration is usually 10 to 14 days. The samplers are retrieved by pulling the device from the borehole with its string. Analysis of the absorbent material is conducted by Methods 8260, 8270 or TO-17. Sample preparation prior to analysis can be very simple and may involve cutting the tip off the bottom of the sampler and transferring an exposed sorbent material to a thermal desorption tube.

Replicate samples, if collected, are retained for approximately two weeks after initial analysis. Two trip blanks should be collected and analyzed for passive soil gas sampling. One trip blank should accompany the passive samplers to the field and then be analyzed. The second trip blank should accompany the samples from the field to the laboratory.

## APPENDIX B POLYMER GAS SAMPLING BAGS AND TUBING TYPES

### Polymer Gas Sampling Bags

Polymer gas sampling bags require similar quality assurance/quality control as other sample containers, specifically container blanks, laboratory control samples and trip blanks. Additional information on quality assurance requirements is presented in Appendix F.

Polymer gas sampling bags should not be reused because contaminants may adhere to the surface of the bag. Also, the bags themselves may off-gas various organic compounds. Manufacture specifications of the bag material should be checked to verify site-specific COCs are compatible.

Relative humidity inside polymer gas sampling bags may affect recovery of polar compounds. Additionally, water may permeate into and out of polymer gas sampling bags during storage.

Advantages are:

- Inexpensive;
- Disposable;
- Easily handled and transported; and
- Recommended for reduced sulfur compounds such as hydrogen sulfide and the fixed gases such as O<sub>2</sub>, N<sub>2</sub>, CH<sub>4</sub>, etc.

Disadvantages are:

- Potential bag material off gassing (toluene and ketones);
- Adsorption of some VOCs;
- Sample loss (mostly via hose valve assembly);
- Limited holding time;
- Vulnerable to puncture;
- Should not be used when moisture content of soil gas is high (condensation);
- Highly polar compounds adhere to the inner surface of the bag; and
- Low molecular weight compounds may permeate the bag.

### Tubing Types

Nyloflow®, polyetheretherketone (PEEK), and Teflon® are recommended tubing materials for soil vapor sampling. Low-density polyethylene (L-D PE) should not be used due to decreased performance relative to other tubing types in both off-gassing of VOCs inherent in the tubing structure (contribution to background) and for decreased recovery (reactivity). Reduced recovery of naphthalene has been observed when using Nyloflow® tubing with small sample sizes.

**Justification**

Nylaflow<sup>®</sup>, PEEK, Teflon<sup>®</sup>, and L-D PE were evaluated for contribution to background. Of the four tubing types, L-D PE exhibited the highest frequency of VOCs and hydrocarbons in background samples and the poorest recovery for target analytes. Some off-gassing of toluene, and to a lesser extent, benzene, propylbenzene and methanol, were noted with the Nylaflow<sup>®</sup> tubing.

The following table summarizes the results of several studies:

**TABLE B-1  
Tubing Type Study Results**

Tubing Type	Study		
	Ouellette (2004)	Hayes and others (2006)	Nicholson and others (2007)
L-D PE	Sorption of hexane and pentane	Sorption of numerous compounds	N/A
Tygon	Sorption of hexane and pentane	N/A	N/A
Nylaflow <sup>®</sup>	Acceptable	Sorption of naphthalene	Sorption of aromatics
Teflon <sup>®</sup>	Acceptable	Acceptable	N/A
Vinyl	Sorption of hexane and pentane	N/A	N/A
PEEK	N/A	Acceptable	N/A

**References**

Hayes, H., N. Khan, and D. Benton. 2006. *Impact of Sampling Media on Soil Gas Measurements*. In Proceedings; Air and Waste Management Association’s Vapor Intrusion Symposium: The Next Great Environmental Challenge – An Update. September 13 – 15, 2006, Los Angeles, California. Pages 69 – 83.

Nicholson, P., D. Bertrand, and T. McAlary. 2007. *Soil Gas Sampling in Low-Permeability Soils*. In Proceedings; Air and Waste Management Association’s Vapor Intrusion Symposium; Learning from the Challenges. September 26 – 28, 2007, Providence, Rhode Island. Pages 299 – 310.

Ouellette, G. 2004. *Soil Vapor Sampling and Analysis – Lessons Learned*. Presented at the Department of Energy / Petroleum Environmental Research Forum Soil Vapor Workshop. January 27 – 29, 2004, Brea, California.



## APPENDIX C      QUANTITATIVE LEAK TESTING USING A TRACER GAS

### Background

High quality soil gas data collection is driven by project-specific data quality objectives (DQOs) and can be enhanced by using a shroud and a gaseous tracer compound. This method of leak detection ensures that soil gas wells are properly constructed and the sample train components do not leak. Gaseous leak check compounds differ from liquid leak check compounds in that liquid leak check compounds can interfere with target analytes. Soil gas samples containing liquid tracers frequently require extensive sample dilution resulting in elevated reporting limits. These elevated reporting limits may not meet project DQOs. Most gaseous tracer compounds do not affect target analyte measurements nor does their detection require sample dilution. Also, gaseous leak tracer compounds allow a quantitative determination of a leak either in the sampling train or from ambient air intrusion down the borehole.

### Shroud Design

The shroud should be designed to contain the entire sampling train and the soil gas well annulus. The size of the shroud depends on the sampling equipment used but should be designed to minimize the shroud volume and gaseous leak tracer compound used. It is easier to maintain initial gaseous leak tracer compound concentrations within the shroud if the shroud volume is kept small, the number of holes in the shroud is kept minimal, and the shroud has good contact with the ground surface. The sampling train should be constructed of material that does not react with the sample analytes and will not off gas or adsorb volatile compounds. The sampling equipment should be clean and shut-in tested prior to use.

Shrouds should be designed for ease of use during purging and sampling, minimizing disturbance of the shroud. The gaseous leak tracer compound concentration inside the shroud should be monitored frequently to verify initial concentrations (See Figure C-1). Shroud design should also take into account the need for duplicate or multi-depth sampling.

Tracer compound detectors provide measurements of tracer gas concentrations inside the shroud and in the purge stream. Several types of detectors are available for field use including hand held, diffusion cell type (inside shroud), and flow through detectors for measuring the purge stream. Alternatively, an external lung box/polymer gas sampling bag setup may be used to quantify tracer compound breakthrough prior to sampling. Detection of tracer compounds prior to sampling enables the samplers to correct the source of the leak(s) or relocate well(s) before taking a compromised soil gas sample.

Soil gas probes installed with good seals throughout the borehole annulus and the use of compression fittings provide assurance against ambient air leaks.

## **Field Use**

A detailed illustrated Standard Operating Procedure should be submitted to the regulating agency for review prior to sampling. Field personnel should be familiar with the procedures and practices necessary to successfully collect soil gas samples using this equipment. If the shroud and sampling train will be reused, all components should be cleaned and shut-in tested prior to reuse.

USEPA Method TO-15 requires sample trains be tested by passing both spiked and clean dry air through the sampling trains to validate performance characteristics.

## **Purging and Sampling**

The tracer compound concentration around the sample train and above the well annulus should be maintained at a minimum concentration. The shroud should be infused with the tracer compound at least five minutes prior to sample collection to allow the tracer compound time to equilibrate (See Figure C-2).

All methods of tracer compound detection should be capable of measuring the tracer compound in air to an accuracy and precision of 0.1 percent. Shroud concentrations should be two orders of magnitude higher than the reporting limit of the laboratory analytical method or the field meter used to analyze the sample. Tracer compound concentrations inside the shroud should be carefully monitored and maintained to correct variations in tracer compound concentration due to wind and uniformity of the ground surface. Additional tracer compound should be added to the shroud incrementally to maintain the desired concentration. Field personnel should record the measured tracer compound concentration in the shroud periodically during the sampling event.

The calculation of a leak is based on the ratio of tracer compound concentration in the shroud to that in the sample, assuming that the tracer compound is continuously infused during sampling. The tracer compound in the shroud should be kept within  $\pm 10\%$  of its target value, and if not achieved then its lowest measured value should be used for calculation purposes.

The soil gas probe and sampling train assembly can be field screened for leaks by drawing purge gas through the well and then through the tracer compound detector while the shroud is in position and filled with the initial tracer compound concentration. Detecting a significant leak in the probe or sampling train at the time of sampling provides the opportunity for the field crew to correct the leak early in the sampling process, thereby ensuring the samples analyzed by the laboratory meet the project-specific DQOs.

If the concentration of the tracer compound in the purge sample is greater than or equal to five percent of the tracer compound concentration in the shroud, corrective action is necessary to either remedy the leak or relocate the probe prior to collecting a soil gas

## ADVISORY – ACTIVE SOIL GAS INVESTIGATIONS

sample. Regardless of the cause of the leak, a data “adjustment factor” based upon the concentration of the leak check compound to compensate for the inability to collect representative samples is inappropriate.

FIGURE C-1

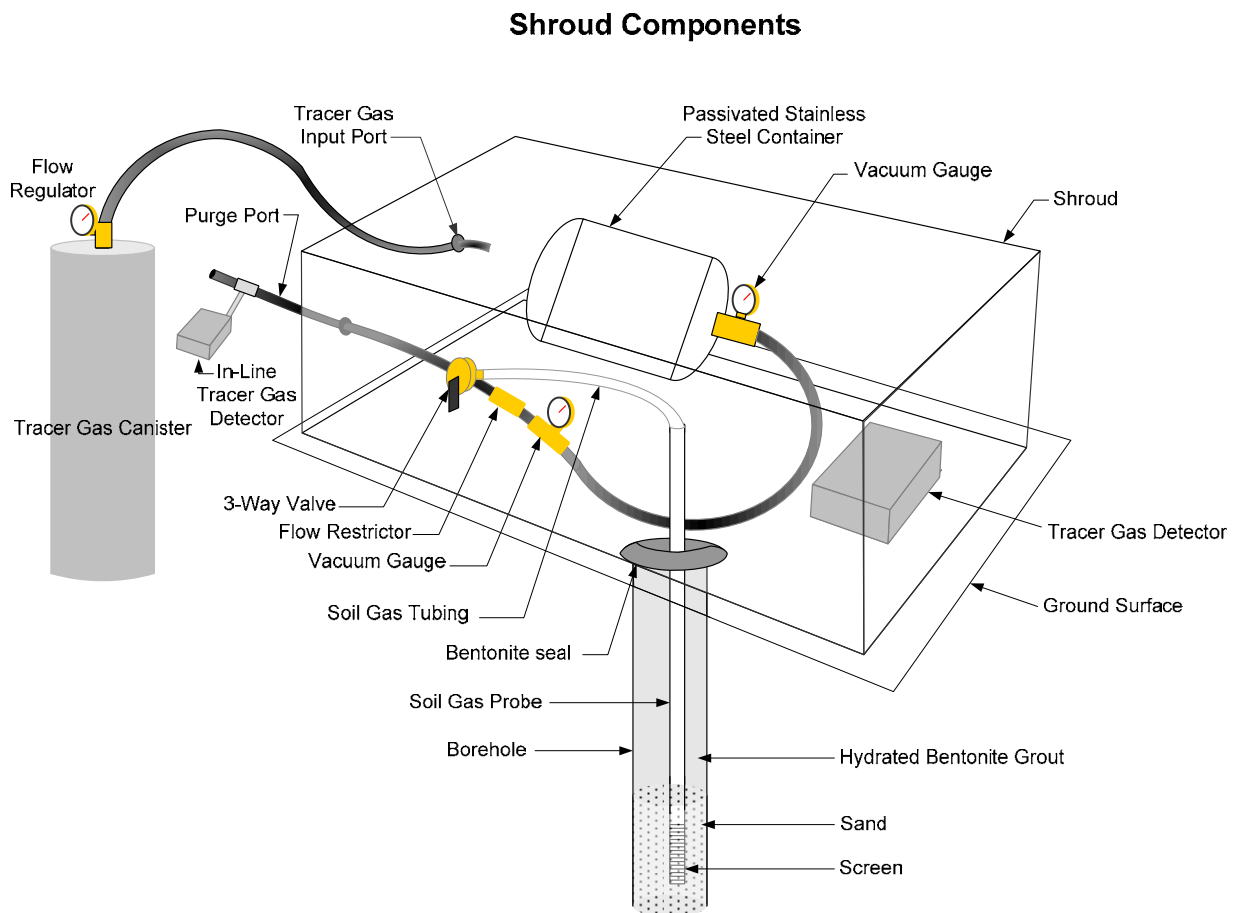
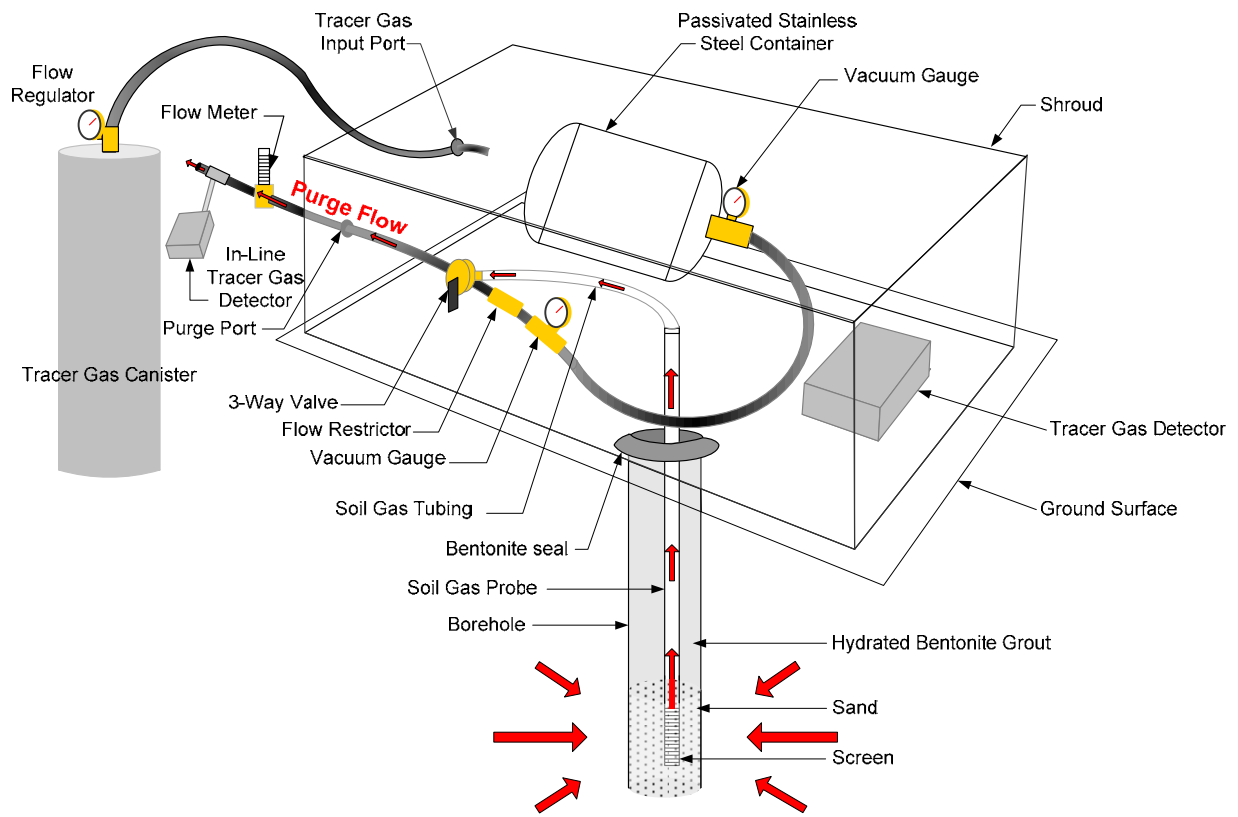

FIGURE C-2

Shroud Components – Purge Conditions



## **APPENDIX D SOIL GAS SAMPLING IN LOW PERMEABILITY SOIL**

Representative soil gas samples can be collected from low permeability soil by utilizing specialized field procedures in addition to the protocols described in the main text of this Advisory. Hence, the procedures described in this Appendix do not replace the recommended procedures in the main text but rather supplement the procedures.

When low flow, high vacuum conditions are encountered during soil gas sample collection, two options are available for field technicians. Sampling can continue at the probe with an alternative sample collection method or the probe can be re-drilled and constructed in a non-traditional manner. Typically, low flow conditions are defined as the inability to maintain an appreciable flow rate (100 mL/min or greater) without applying excessive vacuum (any vacuum greater than about 100 inches of water). In the field, the determination of low flow, high vacuum conditions can be done quantitatively or qualitatively. The probe in question should be subject to applied vacuum for three minutes prior to rendering a decision about flow conditions.

In low permeability soil, it is helpful to initially perform passive soil gas sampling to determine whether active soil gas samples are required at low permeability sites. The passive soil gas samples are used to screen areas for contamination with follow-up active soil gas sampling for risk assessment. Passive soil gas sampling is described in Appendix A.

### **ALTERNATIVE SAMPLING METHOD**

A modified purging and sampling procedure can be used for low flow vapor probes. In a study conducted by McAlary and others (2009), several nested soil gas probes were installed in low-flow conditions, as defined above. About a third of a liter of soil gas was collected from each soil gas probe under an applied vacuum of 100 inches of water before the flow diminished to a negligible amount. Once this vacuum threshold was obtained and it was determined that a flow rate of 100 mL/min was not sustainable, the probe valve was closed to allow the vacuum to dissipate and to allow soil gas to slowly enter the sand pack and tubing from the surrounding soils. When the vacuum dissipated, the probe valve was reopened, and another aliquot of sample was collected. This procedure was repeated until the soil gas probe was adequately purged and sampled. In this manner, probes can be appropriately purged and enough sample volume can be collected for analysis.

If this procedure is used, the rate of vacuum dissipation should be monitored with a dedicated vacuum gauge. The sampling crew may proceed with other nearby activities during the pressure rebound cycle. Additional pressure gauges, fittings, and a flow meter will be needed to implement this procedure in the field. Prior to purging and sampling, the sampling system should be shut-in tested to ensure that vacuum rebound is attributable to subsurface processes and not system leakage. Likewise, leak check compounds should be used during the entire sampling process to confirm the integrity of the sample.

## **REINSTALLATION METHOD**

This approach requires the reinstallation of a vapor probe with a sand pack larger than traditional size. A large sand pack assures the availability of subsurface air for sampling. For this method, the sand pack should have an interstitial void volume of approximately 3 liters, which implies the use of approximately 10 liters of sand for the sand pack. To accommodate this large volume of sand, both the length and the radius of the sand pack must be larger than sand packs typically installed with direct push technology. Approximately ten liters of sand equates to a sand pack length of two feet for a six-inch borehole and a sand pack length of four feet for a four-inch borehole. A study by Neznal and Neznal (2005) indicates that measured radon concentrations in soil gas are not dependent on the subsurface well geometry when the soil is homogeneous and of low permeability.

When using this method, the following should be considered:

- The length of the sand pack should not be longer than the zone of interest;
- The vapor probe tip should be located in the center of the sand pack;
- The top of the sand pack should be at least five feet below surface grade;
- Excessively long sand packs (greater than five feet) should be avoided;
- The diameter of the vapor probe should be small to reduce purge volumes (less than or equal to ¼-inch); and
- The bentonite above the sand pack should be fully hydrated to ensure a high integrity annular seal.

The vapor probe should only be sampled after the sand pack has reached equilibrium with the native material. The establishment of equilibrium can be expected to take approximately two weeks. Purge volume testing should be conducted on the probe to determine optimal purging with one purge volume equating to one tubing volume. Probe tubing size should be selected so that the purge volume does not exceed 200 milliliters. Purging 200 milliliters should not induce any significant vacuum in the probe given the void volume in the sand pack. Excessive vacuum during sample collection can be avoided if the sample collection vessel is small. To avoid excessive vacuum, sample size should be no more than one liter. Vacuum within the vapor probe should be measured to ensure that 100 inches of water is not exceeded during the purging and sampling.

## **AIR PERMEABILITY TESTING**

Air permeability is determined by measuring the gas pressure in a vapor probe as a metered flow of air is passed through the probe. These in-situ tests should only be conducted after soil gas sampling due to potential disruption of subsurface conditions by the movement of air. In-situ testing should continue until steady-state conditions occur. The occurrence of steady-state conditions is defined as less than a 130 Pascal pressure change within 30 minutes. The air permeability is calculated using the data obtained during steady-state conditions. The method also requires the measurement of the soil gas air temperature along with ambient air pressure. See DTSC'S Vapor Intrusion

## **ADVISORY – ACTIVE SOIL GAS INVESTIGATIONS**

Guidance for more information (Appendix J).

### **REFERENCES**

McAlary, T. A., P. Nicholson, H. Groenevelt, and D. Bertrand. 2009. *A Case Study of Soil-Gas Sampling in Silt and Clay-Rich (Low-Permeability) Soils*. *Ground Water Monitoring and Remediation*, v. 29, n. 1, p. 144 -152.

Neznal, M., and M. Neznal. 2005. *Determination of Soil-Gas Radon Concentration in Low Permeability Soil*. *Radioactivity in the Environment*, v. 7, p. 722 – 725.

## APPENDIX E NAPHTHALENE SOIL GAS COLLECTION

Soil gas sampling for naphthalene is more complex than traditional soil gas sampling procedures. Naphthalene analysis by USEPA Method TO-15 presents several challenges, such as contaminant carryover and variability in recovery (Hayes et al., 2005). Likewise, naphthalene readily sorbs onto traditional soil gas sample tubing such as polyethylene and nylaflo (Hayes et al., 2006). USEPA Method TO-15 defines target analytes as having vapor pressures greater than 0.1 millimeter (mm) of mercury (Hg) at standard conditions, and is suitable for organic compounds with carbon content ranging from C3 to C10. However, naphthalene with vapor pressure of 0.087 mm Hg falls just below this threshold and hence is not listed as an analyte for TO-15. USEPA Method TO-17 allows greater flexibility in targeting lower vapor pressure compounds, and hydrophobic sorbents can trap organic compounds ranging from C7 to C20. Nonetheless, naphthalene samples can be analyzed by both USEPA Methods TO-15 and TO-17 provided the appropriate protocols described below are followed. Table E1 is a comparison of the two methods, and can be used to assist practitioners in the selection process in conjunction with the project's data quality objectives (DQOs).

To collect a naphthalene sample, the entire sampling system should be composed of Teflon<sup>®</sup>, polyetheretherketones (PEEK) or other tubing types with demonstrated inertness (Hayes et al., 2006). Using proper materials in the sampling system will ensure that soil gas samples are representative of subsurface conditions. Soil gas sampling workplans should describe how the field investigation will meet all the recommendations within this appendix as well as those noted in the USEPA TO methods. Both passive and active soil gas samples may need to be collected in order to provide multiple lines of evidence to evaluate vapor intrusion exposure to naphthalene.

### Naphthalene Sample Collection by TO-15 (USEPA, 1999a)

Many stationary laboratories are capable of obtaining naphthalene data of acceptable quality using TO-15. If TO-15 is used for naphthalene sampling, then the laboratory conducting the analysis should utilize certain procedures, as follows:

- 1) **Naphthalene Recovery:** Naphthalene may condense onto the interior surface of sampling canisters. Therefore, storage stability tests with prepared naphthalene vapor standards should be performed for the duration of expected holding times. These storage stability tests should be conducted in the laboratory using certified clean canisters. Acceptable recovery of naphthalene should be demonstrated using a gas standard at a concentration of 32  $\mu\text{g}/\text{m}^3$  or less prepared in a passivated canister of the same make and approximate age as those used for sampling. The recovery testing information should be provided in the laboratory reports.
- 2) **Naphthalene Carryover:** Laboratory blanks should be used to check for instrument carryover. The blank should be run after the introduction of the highest naphthalene standard used to generate the instrument's calibration curve. Likewise, blanks should be run after the analysis of soil gas samples with



## ADVISORY – ACTIVE SOIL GAS INVESTIGATIONS

high naphthalene concentrations. Any instrument carryover of naphthalene from the blank sample should be substantially lower than the reporting limit to assure that the analyses are not compromised. The laboratory blank information should be provided in the laboratory reports.

- 3) **Canister Cleanliness:** Canisters used for naphthalene analysis should be certified clean before and after use, and the certification sheets provided in the laboratory reports. The canisters can be either batched or individually certified dependent upon the project's data quality objectives.
- 4) **Canister Age:** Laboratories should consider utilizing newer canisters for naphthalene sample collection. In older canisters, the passivated interior surface degrades over time, allowing greater surface area for the sorption of naphthalene. The age of the sampling canisters should be provided in the laboratory reports.
- 5) **Matrix Spikes (MS) and Matrix Spike Duplicates (MSD):** As stated in Table 2 in the Advisory and repeated in Appendix F, MS and MSD are impractical and not required when using TO-15.

If TO-15 is used for naphthalene sampling, TO-17 should be used to confirm TO-15 sampling results at a frequency of five to ten percent of the field samples. The number of confirmatory samples should be a function of the data quality objectives for the site. Confirmation sampling is especially prudent when using data for risk assessment purposes or when verifying cleanup objectives.

### Naphthalene Sample Collection by TO-17

Soil gas samples for analysis by TO-17 are collected in sampling tubes packed with an appropriate sorbent material. USEPA (1999b) contains lists of chemicals amenable to TO-17 analysis along with guidelines for sorbent selection. For naphthalene, the sorbent material is usually Tenax<sup>®</sup> GR or Tenax<sup>®</sup> TA, but others may be appropriate. Practitioners should reference Table I in the Compendium of Methods for the Determination of Toxic Organic Compounds in Ambient Air, Second Edition (USEPA 1999b). The air flow rate through the tubes is monitored during sample collection and a vacuum of less than 100 inches of water should be maintained during sampling. Shut-in tests should be conducted and leak check compounds should be used to evaluate sample integrity.

Items to consider when soil gas sampling pursuant to TO-17 are as follows:

- 1) **Practitioner's Unfamiliarity:** Practitioner's unfamiliarity with sampling by TO-17 may lead to field errors, potentially reducing the integrity of the sampling data.
- 2) **Perceived Limitations with Sorbent Tubes:** Other concerns and perceived limitations with use of the sorbent tube include lack of repeat analysis for samples collected by TO-17, breakthrough of target analytes during sampling and potential mass spectrometer overload from high concentration samples. To

## ADVISORY – ACTIVE SOIL GAS INVESTIGATIONS

address these concerns, practitioners should consider pre-screening all soil gas samples subject to TO-17 procedures. By estimating the anticipated concentration range of the sample prior to sorbent tube sampling, practitioners can determine optimal sampling durations to avoid breakthrough and provide notification to the stationary laboratory about possible instrumentation overload. Field equipment capable of measuring in the microgram per cubic meter range may be warranted.

- 3) **Breakthrough Volumes:** The sampling air volume is calculated from the anticipated subsurface concentration, sampling tube sorption capacity and sorbent tube temperature. Equations for breakthrough are typically provided by either the sorbent tube manufacturer or the analytical laboratory. Calculations for breakthrough should include an adequate safety factor to ensure that breakthrough does not transpire during sampling. If breakthrough volumes cannot be determined due to unknown conditions, sorbent tubes should be arranged in series and all tubes should be submitted to the laboratory for analysis.
- 4) **Pump Placement:** The sorbent tube should be upstream of the sampling pump.
- 5) **Sample Collection Flow Rate:** Flow rates for sample collection are typically less than 50 milliliters per minute, and the flow rate should not vary by more than 10 percent during sample collection.
- 6) **Sorbent Tube Orientation:** Tube orientation is usually annotated on the tube by the sorbent manufacturer or laboratory. For thermal desorption methods, the sorbent tube must be oriented during sample collection in the direction indicated on the tube. Multiple tubes may be placed in series in the sampling train if analytes other than naphthalene are required or if duplicate samples are necessary.
- 7) **Field Documentation:** Data sheets should be completed in the field and submitted to the analytical laboratory. The sheets should contain the sampling flow rates and sampling volumes required to quantify contaminant concentrations. These field data sheets should be included within the characterization report.
- 8) **Leak Check Compounds:** Leak test compounds should be used to verify sample integrity when sampling pursuant to TO-17, but it should be noted that most sorbent tubes will not retain many typical leak check compounds. For example, compounds smaller than C7 are not captured by Tenax® GR or Tenax® TA. In these situations, practitioners cannot depend upon the analysis of sampling tube for quantification of the leak check compound. Instead, additional sampling and analytical procedures may be warranted. Leakage can be readily measured and quantified on-site with a field meter, or by a stationary laboratory after the soil gas sample is collected. If a leak test compound with a carbon range of greater than C7 is used, the additional mass absorbed onto the sorbent tube may elevate the reporting limit or even overload the mass

## ADVISORY – ACTIVE SOIL GAS INVESTIGATIONS

spectrometer upon analysis. Additionally, a shut-in test of the above-ground apparatus downstream from the probe should be performed prior to sampling.

- 9) **Collection Tube Composition:** Sorbent tubes composed of metal should be used due to potential photochemical reactions. However, if only glass sampling tubes are available, the tubes should be wrapped entirely in aluminum foil during and after sample collection to avoid photodegradation.
- 10) **Duplicate Samples:** Duplicate sorbent tube samples should be collected at a predetermined frequency, usually at a rate of 10 percent of the number of samples.
- 11) **Trip Blanks:** Each shipping cooler should contain a trip blank. The trip blank should be a sealed tube filled with the same sorbent used during the field procedures.

### Other Analytical Methods for Naphthalene Sample Collection

- 1) **Method 8260:** Due to the potential for low data quality when collecting and analyzing naphthalene soil gas samples pursuant to Method 8260, sample results should not be used for risk assessment purposes. Similar to the concerns about naphthalene analysis by TO-15, Method 8260 presents issues concerning contaminant carryover, variability in recovery and sorption to sampling equipment, such as plastic and glass syringes, glass bulbs and Tedlar bags.
- 2) **TO-13A:** Naphthalene analysis by TO-13A is not recommended. While TO-13A procedures are similar to TO-17 in many respects, two fundamental differences exist. First, the sorbent material within the sampling tubes for TO-13A is composed of polyurethane foam, typically PUF® and XAD-2®. Second, the sorbent material is removed by solvent (soxhlet) extraction prior to introduction into the gas chromatography/mass spectrometry instrumentation rather than by thermal desorption as in TO-17. Both PUF® and XAD-2® are known to have marginal collection efficiency for vapor phase naphthalene. Additionally, there is a potential for substantial losses of naphthalene due to its tendency to sublime and its relatively high vapor pressure during TO-13A soxhlet extraction and evaporative concentration (Fortune et al., 2010).

**TABLE E-1  
Comparison of Methodologies**

Issues	TO-15	TO-17
Application to naphthalene	Naphthalene is not a listed constituent due to its low vapor pressure.	Method specifically designed for constituents with low vapor pressure.
Familiarity with method	Method is commonly used.	Method is not widely used. Some laboratories may not have the necessary analytical equipment.
Sample collection	Canisters are expensive, expensive to clean, and bulky to transport. Only one sampling canister is needed per sample if numerous constituents warrant analysis. Sample remains stored as a gas until analysis.	Sorbent tubes are inexpensive as compare to canisters, and are small and easy to transport. Numerous sampling tubes may be needed if numerous constituents warrant analysis. Samples are no longer in the gas phase once collected, and hence, less likely to interact or react until analysis.
Sample analysis	The GC/MS analysis is the same for both methods. The difference is how the sample is introduced into the GC.	The GC/MS analysis is the same for both methods. The difference is how the sample is introduced into the GC.
Sample recovery	Naphthalene may sorb into the interior surface of the sampling canister, biasing the sampling results.	Naphthalene readily desorbs from the sampling tube material.
Sampling rate	Canister sampling rate is controlled by a regulator which is pre-calibrated and usually provided by the laboratory.	Sampling rate is controlled by a purge pump in the field. Hence, the field crew is responsible for maintaining the flow rate and for determining the sample volume.
Subsurface concentration	Highly concentrated samples can be handled, but canisters need to be cleaned thoroughly afterward.	Constituent breakthrough can occur without realization, compromising the integrity of the sample.
Capacity for multiple runs	Multiple analyses can be performed on the canister air if needed.	Typically, only one analytical run is possible on a sorbent tube. Samples cannot be diluted in most cases.
Detection limits	Typically greater than 10 $\mu\text{g}/\text{m}^3$ for naphthalene.	Typically less than 10 $\mu\text{g}/\text{m}^3$ for naphthalene.
Water management	Both methods are effective in removing water. Sorbent trap in the concentrator allows for the passage of some water, and then a dry gas purge is performed prior to thermal desorption in the GS/MS.	Both methods are effective in removing water. Uses a combination of hydrophobic sorbents, and then a dry gas purge is performed prior to thermal desorption in the GS/MS.
QA/QC	Analytical QA/QC is same for both methods.	Analytical QA/QC is same for both methods. Relatively extensive QA/QC on the sorbent tubes before and during sampling.

## REFERENCES

- Fortune, A., M. Taday, and L. Gendron. 2010. *Comparison of Naphthalene Ambient Air Sampling and Analysis Methods at Former Manufactured Gas Plant (MGP) Remediation Sites*. In Proceedings; Annual International Conference on Soil, Sediment and Water, v. 14: Iss. 1, Art. 2.
- Hayes, H., D. Benton, S. Grewal, and N. Khan. 2005. *A Comparison between EPA Compendium Method TO-15 and EPA Method 8260B for VOC Determination in Soil Gas*. In Proceedings; Air and Waste Management Association's Symposium: Air Quality Measurement Methods and Technology. April 19 – 21, 2005, San Francisco, California.
- Hayes, H., N. Khan, and D. Benton. 2006. *Impact of Sampling Media on Soil Gas Measurements*. In Proceedings; Air and Waste Management Association's Vapor Intrusion Symposium: The Next Great Environmental Challenge – An Update. September 13 – 15, 2006, Los Angeles, California. Pages 69 – 83.
- United States Environmental Protection Agency. 1999a. *Compendium Method TO-15, Determination of Volatile Organic Compounds (VOCs) In Air Collected In Specially-Prepared Canisters and Analyzed By Gas Chromatography/Mass Spectrometry (GC/MS); Compendium of Methods for the Determination of Toxic Organic Compounds in Ambient Air*, Second Edition. Center for Environmental Research Information, Office of Research and Development. January 1999.
- United States Environmental Protection Agency. 1999b. *Determination of Volatile Organic Compounds in Ambient Air Using Active Sampling onto Sorbent Tubes; Compendium Method TO-17. Compendium of Methods for the Determination of Toxic Organic Compounds in Ambient Air*, Second Edition. Center for Environmental Research Information, Office of Research and Development, Cincinnati, Ohio. January 1999.

## APPENDIX F SOIL GAS ANALYTICAL METHOD REVIEW

### SOIL GAS ANALYSIS METHODS

There are two methods generally used in California for soil gas analysis. One is Gas Chromatography with Mass Spectrometer (GC/MS), which is able to confirm the identity of compounds. The second is GC with a single specific detector such as a Flame Ionization Detector (FID), Electron Capture Detector (ECD), Photoionization Detector (PID) or a series of these detectors. The GC/MS technique is preferred because of its specific compound identification ability.

There are no approved USEPA methods specifically designed to analyze volatile organic compounds (VOCs) and semi-volatile organic compounds (SVOCs) in soil gas samples. Consequently, modified versions of existing USEPA methods are used to analyze soil gas samples.

The modifications made to accommodate soil gas samples include the sample introduction technique and the calibration approach. It is important for consultants, regulators and other stakeholders to evaluate the technique(s) being employed before work begins on a site. All of the modifications have advantages and disadvantages with some working better for certain compounds than others. Project data quality objectives should be the deciding factor on which technique is the best to use for each phase of work on a particular site. If possible, the parties involved should perform preliminary performance tests or trial runs using a selected number of techniques and determine the best method to use on the site.

### PERFORMANCE-BASED MEASUREMENT SYSTEM

This appendix summarizes some common methods used to analyze soil vapor samples. Laboratories are not restricted to the methods described in this document. Modifications and other adjustments may be needed to accommodate matrix, background, or other analytical issues. These modified methods can be used provided they have been validated and it can be demonstrated that the modified methods are capable of meeting the project data quality objectives and established performance criteria. Innovations and creativity are encouraged.

Methods that do not follow the specifics of published written methods (such as USEPA Method TO-15) but have been validated and can be demonstrated to be effective are considered to be “performance-based measurement system” (PBMS) with stipulations.

USEPA published the PBMS in 1997. The intent of PBMS was to allow the regulated community to select any suitable analytical method for regulatory compliance, to improve data quality and to encourage development of better analytical techniques. PBMS conveys what needs to be accomplished, but does not prescriptively describe how to do it. PBMS are defined as a set of processes where the data needs of a program or project are specified, and serve as the criteria for selecting appropriate methods to meet data or project objectives.

## **ADVISORY – ACTIVE SOIL GAS INVESTIGATIONS**

Since there are no analytical methods specifically designed to analyze soil gas samples, laboratories may develop and implement PBMS for soil gas samples. PBMS can be used for soil gas samples provided the criteria stated above are met, specifically that:

- The process can be validated;
- It can be demonstrated that the process can meet project data quality objectives; and
- It can be demonstrated that the process can meet the specified method performance criteria.

Laboratories may independently validate their PBMS. All validation documentation, such as raw data, should be kept on file and available for review by parties that may have vested interests in a particular project.

The regulating agency should review all PBMS in detail before accepting the proposed modification. Data from projects where the proposed PBM will be used should be compared side-by-side with an existing method. The proposed PBMS should be scrutinized to make sure they are not simply short-cut methods disguised as performance-based measurement systems.

Project consultants and contractors should provide the necessary documentation to support the use of any proposed PBMS for a project. Documentation should substantiate that the proposed method is capable of meeting the project data quality objectives and meet performance criteria.

Laboratory results from a PBM should reference the method used as “Performance-Based” followed by the base method. For example, if the PBM is based on USEPA Method TO-15, then the method should be referenced as “Performance-Based USEPA Method TO-15.” In the report narrative, a short description of the modification and/or adjustment made to the established method should also be included.

## **HISTORICAL AND LATEST VERSIONS OF ANALYTICAL METHODS**

Multiple versions of USEPA methods exist. Analytical methods are revised in order to add more analytes, update instrumentation and clarify requirements and recommendations. Most revisions do not involve substantial changes to the method technique. In general, laboratories should use the latest method revision in their work. However, before using a new revision, laboratories should carefully review and compare their existing method with the new revision to verify that there are no significant changes that can affect data quality and the data quality objectives of their clients. Likewise, laboratories using older revisions of methods, for historical or consistency reasons, should confirm that the older method version will serve the intended purpose. Laboratories should clearly indicate the exact revision of the method used in their laboratory reports to their clients.

## ADVISORY – ACTIVE SOIL GAS INVESTIGATIONS

Letter suffixes to a method such as “A”, “B”, etc. are used to identify the revision status of the method. The first version of a method (revision “0” [zero]) does not have a letter suffix.

Occasionally a revision or method may be declared obsolete by the USEPA and should therefore no longer be used by laboratories. For the current status of USEPA methods, refer to the Status Tables for SW-846, Third Edition.

Table F-1 displays the various versions of USEPA methods referenced in this advisory modified for soil gas testing:

**TABLE F-1  
USEPA Soil Gas Testing Methods**

USEPA Method	Description	Revisions (Date)	Comments
8015	Nonhalogenated Organics by Gas Chromatography	0 (September 1986) A (July 1992) B (December 1996) C (February 2007) D (June 2003)	Revision D is the latest revision in spite of the later date for revision C. Revision C was introduced in 2000 as a draft update, but not finalized until 2007.
8021	Aromatic and Halogenated Volatiles by Gas Chromatography Using Photoionization and/or Electrolytic Conductivity Detectors	0 (July 1992) A (September 1994) B (December 1996)	Replaced methods 8010 and 8020.
8260	Volatile Organic Compounds by Gas Chromatography/Mass Spectrometry (GC/MS)	0 (July 1992) A (September 1994) B (December 1996) C (August 2006)	
TO-13A	Polycyclic Aromatic Hydrocarbons (PAHs) in Ambient Air Using Gas Chromatography/Mass Spectrometry (GC/MS)	First Edition (TO-13) (March 1989) Second Edition (January 1999)	“Edition” refers to the Compendium of Methods for the Determination of Toxic Organic Compound in Ambient Air, and not the revision of the method.
TO-15	Volatile Organic Compounds (VOCs) in Air Collected in Specially-Prepared Canisters and Analyzed By Gas Chromatography/Mass Spectrometry (GC/MS)	Second Edition (January 1999)	Method TO-15 was a new method added to the Second Edition of the Compendium of Methods for the Determination of Toxic Organic Compounds in Ambient Air. TO-15 is based on Method TO-14A.
TO-17	Volatile Organic Compounds (VOCs) in Ambient Air Using Active Sampling Onto Sorbent Tubes	Second Edition (January 1999)	Method TO-17 was a new method added to the Second Edition of the Compendium of Methods for the Determination of Toxic Organic Compounds in Ambient Air. It is an update of Methods TO-1 and TO-2 from the first compendium (1989).



## MODIFIED GC/MS METHODS

### USEPA Method 8260

USEPA Method 8260 (Volatile Organic Compounds by Gas Chromatography/Mass Spectrometry (GC/MS)) is designed to determine the concentration of VOCs in a variety of solid and liquid matrices (USEPA, 2000). There are two modifications made to this analytical method for soil gas sampling. In the first modification, a volume of soil gas sample is injected into the sparge vessel (sparger) containing water. Helium gas is then used to purge the VOCs out of the sparger and onto a sorbent trap. VOCs in the sorbent trap are thermally desorbed into the GC column for separation and analysis. This is equivalent to USEPA Method 5030 (Purge-and-Trap for Aqueous Samples). In the second modification, a small volume of the soil gas sample is directly injected into the GC.

Laboratories employing a modification of USEPA Method 8260 to analyze soil gas samples should adhere to all the analytical requirements of the original method including purge time, calibration and Quality Assurance/Quality Control (QA/QC). Modifications for soil gas samples are outlined in the following sections.

#### **a) Sample Introduction**

The original USEPA Method 8260 outlines five specific methods for sample introduction, none of which were designed for soil gas. Therefore, modifications of the introduction step are needed for soil gas samples. DTSC contacted several stationary and mobile laboratories that use Method 8260 for soil gas, and determined that soil gas samples are usually introduced by either purge-and-trap or direct injection, as described above. Each sample introduction technique has its own advantages and disadvantages. The advantages and disadvantages are summarized in Table F-2.

**TABLE F-2**  
**Advantages and Disadvantages of 8260 Sample Introduction Techniques for Soil Gas**

Sample Introduction Technique	Advantages	Disadvantages	Comments
<p>A volume of soil gas sample is injected into a purge-and-trap sparger containing water. Analytes are purged out of sparger into the sorbent trap using helium gas. Analytes in the trap are thermally desorbed into the GC column for separation.</p>	<ul style="list-style-type: none"> <li>• Larger volumes of soil gas sample may be forced into water to achieve lower reporting limits with limitations.</li> <li>• Surrogates, internal standards and spikes are added into the sparger before sample introduction and purging.</li> <li>• Soil gas volumes can be changed by using a smaller syringe or concentrated soil gas samples can be diluted in glass bulb before injecting into sparger.</li> </ul>	<ul style="list-style-type: none"> <li>• Analytes are forced into a water matrix and purged out into trap before entering into GC column. Loss of target analytes possible.</li> <li>• Depending on the type of sample container/vessel in which the sample is collected, sample may need to be transferred before injection into sparger –potential sample loss in transfer process.</li> <li>• Low recovery of polar/water soluble compounds.</li> <li>• Calibration curve not matrix-matched if liquid standards are used.</li> </ul>	<ul style="list-style-type: none"> <li>• Not recommended for polar/water soluble compounds.</li> <li>• Surrogates (liquid-phased) are used, but introduced separately into sparger. Does not actually provide true QA/QC information on soil gas.</li> <li>• Ideal for higher concentration samples.</li> <li>• Not recommended for low level (low concentration) samples.</li> <li>• Not recommended for oxygenates and chlorinated compounds due to poor purging efficiency.</li> </ul>
<p>Direct injection of soil gas sample into GC column for separation.</p>	<ul style="list-style-type: none"> <li>• Technique is quick with limited sample handling.</li> <li>• Holding time not an issue, provided samples are injected immediately after collection.</li> <li>• No transfer of analytes from one phase to another (i.e., gas to liquid to gas).</li> <li>• Can handle high level (concentrated) samples.</li> </ul>	<ul style="list-style-type: none"> <li>• Limited sample size; threshold limit on how much sample can be injected into GC column may result in elevated reporting limits</li> <li>• Elevated reporting limits may not meet the DQOs for risk assessment purposes.</li> <li>• Calibration not matrix-matched.</li> </ul>	<ul style="list-style-type: none"> <li>• Recommended for screening purposes (qualitative data) and routine monitoring of limited number of known compounds.</li> <li>• Calibration standards prepared by expansion of liquid standards in vials/bulb may not be amenable to all compounds.</li> </ul>

**b) Calibration for 8260**

Analytical laboratories should use vapor-phase standards to calibrate their instruments when employing USEPA Method 8260B/C for soil gas analysis. Vapor-phase standards used for ambient air testing are readily available and can be used for soil gas analyses. Many laboratories use liquid-phase standards to prepare the calibration curve, for logistical and economic reasons, rather than using a vapor-

phase standard. This is problematic because the vapor pressure, solubility, and other properties of a compound may be different in a liquid-phase standard than in a vapor-phase standard, especially when it is subjected to being forced into an aqueous phase in the sparger and then forced out into a gaseous phase again during the purge. Therefore, the calibration curve should be matrix-matched by using a vapor-phase standard.

Some laboratories are essentially using a headspace technique modification that attempts to matrix-match a liquid-phase calibration standard to soil gas samples. The technique entails injecting the liquid standard into an empty volatile organic analysis (VOA) vial through the septum or into glass bulbs and allowing the standard to vaporize and equilibrate before taking an aliquot of the vapor and injecting it into the gas chromatograph. This technique may not be amenable to all VOCs since it is dependent on the vapor pressures of the target analytes and how well each compound will vaporize in the vial or bulb. The few laboratories that use this technique are analyzing a limited number of analytes. Laboratories using this approach should standardize their temperature range, time for equilibration, and other practices in preparing the calibration standards. Furthermore, laboratories using this technique should validate and verify the accuracy of their vaporized standards by comparing their calibration with vapor-phase standards (see next section).

### **c) Calibration Validation for 8260**

Calibration curves are validated by analyzing a mid-level National Institute of Standard and Technology (NIST) traceable vapor-phase validation check standard on a routine basis. The vapor-phase validation check standard, or equivalent, should be analyzed and evaluated every time a calibration curve is generated. Routinely, a vapor-phase check standard should be analyzed with each analytical batch to verify the validity of the liquid calibration curve. In addition, the vapor-phase validation check standard should include all the target analytes in the calibration curve. Because the purging characteristic of each compound is different, laboratories should establish their own acceptance criteria for each compound for the validation. The acceptance criteria should be based on experimental and/or historical data. This validation procedure is recommended, regardless of the sample introduction technique being used, to provide technically sound and defensible data.

For laboratories that calibrate their analytical system using the headspace technique, validation of the calibration curve should be conducted by injecting an aliquot of a vapor-phase NIST traceable or equivalent standard at a volume equal in concentration to the mid-point of the calibration curve to validate and to verify the accuracy of their standard preparation technique. The volume needs to be calculated based on the volume of the vaporized standard injected and the concentration of the standard. The frequency of the validation, percent differences of validation check and reportable data should be the same as for liquid standards.

If vapor-phase standards are used to prepare the calibration curve with USEPA Method 8260B, the validation referenced above is not necessary. However,

## ADVISORY – ACTIVE SOIL GAS INVESTIGATIONS

analytical laboratories should verify the accuracy of their vapor-phase standards periodically by comparing them to a secondary standard either from another source or to a different lot of standards from the same supplier.

### **d) Sample Volume for 8260**

The sample volume is determined by the sample introduction technique in conjunction with the project reporting limits. If lower reporting limits are desired, then a larger volume of sample should be injected. The volume for the direct injection technique is limited since only a very small volume can be injected onto the GC, whereas a larger volume can be used with the sparger technique. Sample volumes of five to 250 milliliters (mL) are typically used, although some laboratories use up to 500 mL of sample.

Larger volume samples are introduced in aliquots into a sparger filled with water by forcing the water directly through the trap. The contact time with the water is minimal. More water-soluble compounds such as ketones and methyl tertiary butyl ether will preferentially stay in the water phase until purged out.

Laboratories should validate their injection technique by injecting aliquots of vapor-phase standards into the sparger and evaluating the recovery levels. The recommended recovery range is 70 to 130 percent for most compounds.

### **e) Purge Time for 8260**

USEPA Method 8260B specifies a purge time of 11 minutes. Laboratories should not deviate from this specification as the method is optimized for the recovery of all target analytes. If modifications are required, they should be documented and validated with vapor-phased standards.

### **f) Autosamplers for 8260**

Using an autosampler with modified USEPA Method 8260B/C is not reliable. The soil gas sample is transferred for analysis from a soil gas collection vessel such as a syringe to another secondary container such as a VOA vial, resulting in sample loss. This technique is not capable of handling variable volumes of soil gas sample, especially larger sample volumes needed to adjust for the desired site-specific compound RLs. Furthermore, gases and the more water-soluble compounds have questionable recoveries.

### **g) Screening**

When using a GC/MS, laboratories should screen samples before analysis with a GC/FID to avoid saturation of the mass spectrometer. This will also provide information on the proper dilution(s) needed for quantification.

### **h) Applicability of 8260**

Modified Method 8260B works well for soil gas samples with VOC concentrations greater than 0.1  $\mu\text{g/L}$  or 100  $\mu\text{g/m}^3$  and for most compounds.

### **i) Other Modifications**

The project proponent should propose method modifications to the regulatory agencies prior to implementation, leaving an adequate time for regulatory review and comment. Standard operating procedures (SOP) for the modified sample preparation and analysis should be provided. The laboratory using the modification must validate the procedures before implementation and provide the data and report for review. Refer to the Performance-Based Measurement System Section above.

## **USEPA Method TO-15**

Although TO-15 (USEPA, 1999) was designed for collecting and analyzing VOCs in ambient air samples, this method can successfully be used for soil gas analysis. A known volume of sample is collected into a passivated stainless steel canister, then concentrated onto a solid sorbent trap in the laboratory and refocused on a second trap before being thermally desorbed onto the GC column for separation.

There are two techniques for introducing whole air samples by TO-15 from the canister into the gas chromatograph. These are the multisorbent pack method and a cold trap method. The multisorbent pack method uses different types of solid sorbent traps with different retentive properties selectively concentrating VOCs depending on the analytes. The cold trap method concentrates VOCs by condensing them on a cold surface.

TO-15 was designed for ambient air where the analyte concentrations have a narrow concentration range. In contrast, soil gas samples have a wide range of concentrations. Therefore, soil gas samples should be pre-screened before analysis. Pre-screening provides for adjusting the operating parameters such as dilution and recalibration to avoid overloading the instrument and/or creating problems such as carryovers.

Of all the USEPA methods, Method TO-15 is best suited for soil gas analysis since it is designed for gas samples. Laboratories employing TO-15 to analyze soil gas samples should adhere to all the basic requirements of the method including calibration and QA/QC protocols.

Advantages and disadvantages of TO-15 modifications are described in Table 3. Since a soil gas sample is treated in the same manner as an ambient air sample, there should be no modification needed to analyze soil gas samples with this method.

**TABLE F-3**  
**Advantages and Disadvantages of Modifications to TO-15**

Modification	Advantages	Disadvantages	Comments
Samples collected in polymer gas sampling bags	<ul style="list-style-type: none"> <li>• Lower Cost;</li> <li>• Easily transported</li> <li>• Selected compounds have been shown to be stable.<sup>1</sup></li> </ul>	<ul style="list-style-type: none"> <li>• Potential background issues (bag off-gas);</li> <li>• Adsorption of some compounds;</li> <li>• Bags do not conform to TO-15 protocol; and</li> <li>• Limited holding time (6 hours).</li> </ul>	
Samples injected into instrument by filling injection loop with syringe	<ul style="list-style-type: none"> <li>• Good for highly concentrated samples.</li> </ul>	<ul style="list-style-type: none"> <li>• Limited volume can be analyzed (0.5 – 5 cc); and</li> <li>• Not suited for low concentration samples.</li> </ul>	<ul style="list-style-type: none"> <li>• May only be used for highly concentrated samples.</li> </ul>
Use of portable GC/MS system (e.g., Hapsite®) <sup>2</sup>	<ul style="list-style-type: none"> <li>• Ideal for field screening.</li> </ul>	<ul style="list-style-type: none"> <li>• May not be able to handle the various types of sampling media. Samples have to be transferred for analysis (e.g., canister to syringe or polymer gas sampling bag).</li> </ul>	<ul style="list-style-type: none"> <li>• Considered to be an automated gas chromatograph under Section 1.6 of method.</li> </ul>

<sup>1</sup> Hartman (2006)

<sup>2</sup> DTSC Environmental Chemistry Laboratory should be consulted.

**a) Quality Assurance/Quality Control for TO-15**

The QA/QC requirements for Method TO-15 differ from USEPA Method 8260B/C. The calibration curve and tuning need to be checked every 24 hours for Method TO-15 compared to every 12 hours for Method 8260B/C. There are no requirements to verify the calibration curve with a second-source standard, to analyze matrix spike/matrix spike duplicate samples (MS/MSD), to run laboratory control samples (LCS) or to use surrogates for Method TO-15.

**b) Use of Autosamplers for TO-15**

Samples in passivated stainless steel canisters may be analyzed without any further sample transfer if the canisters are directly connected to an autosampler. Additional blank samples should be included in the sample sequence to evaluate possible carryover of highly contaminated samples.

Samples in polymer gas sampling bags may also be analyzed with an autosampler provided the sample container is connected in such a way to ensure there is no leakage. A vacuum pump is needed to pull the sample into the instrument. Additional blank samples should be included in the sample sequence to evaluate possible carryover of highly contaminated samples.

## ADVISORY – ACTIVE SOIL GAS INVESTIGATIONS

Polymer gas sampling bags are sometimes used for dilution of highly concentrated samples from canisters. The bags used for dilutions should be new and thoroughly cleaned.

### **c) Canister Certification for TO-15**

Although canister certification may not be appropriate for all projects, certifying canisters as clean canisters decreases the level of uncertainty associated with the prior use of the canister. Certified canisters are leak tested and documented to be clean and free of any contaminants. The project DQOs dictate the certification level and certification frequency. The certification level is determined by the reporting limits. The certification frequency refers to the number or percent of canisters requiring certification. Canisters should be certified with the same data acquisition mode as the sample analysis.

Soil gas samples collected in canisters may be shipped since they are under vacuum. The Department of Transportation (DOT) in title 49 Code of Federal Regulations, Parts 100-185, requires that canister pressure must not exceed 400 pound-force per square inch gauge (psig). Consult with the federal code of regulations and the shipping agent on specific regulations pertaining to shipping and transporting various materials.

### **USEPA Method TO-17**

Method TO-17 (USEPA, 1999) is primarily a sampling method coupled with the analytical approach used in USEPA Method TO-15. In TO-17, a known volume of soil gas is pulled through a sorbent tube to collect the VOCs followed by VOC desorption onto the GC column for separation and analysis by the mass spectrometer. Other detectors or combinations of detectors, such as the ECD/FID in series, can be used with this method provided that the criteria specified in Section 14 of the method are met.

Like TO-15, TO-17 was designed for collecting and analyzing VOCs in ambient air samples, but can successfully be used for soil gas sampling and analysis.

Since a soil gas sample is treated in the same manner as an ambient air sample, there should be no modification needed to analyze soil gas samples with this method.

### **a) Conditioning and Calibration for TO-17**

Freshly packed or new sorbent tubes must be conditioned before use. Conditioning entails heating the tubes at specific temperatures with a set gas flow rate (See Table 2 of method). Tubes can be reused for multiple thermal desorption cycles until the safe sampling volume validation procedures fails (USEPA, 1999, Method TO-17, Section 13.1.2).

## ADVISORY – ACTIVE SOIL GAS INVESTIGATIONS

For calibration, either vapor-phase or liquid standards can be used. Liquid standards are directly injected into the sorbent tubes for calibration. No calibration validation with gas-phase standards is needed if liquid standards are used.

According to USEPA 1999, “Sample tubes awaiting analysis on an automated desorption system must be completely sealed before thermal desorption to prevent ingress of VOC contaminants from the laboratory air and to prevent losses of weakly retained analytes from the tube.” (Method TO-17, Section 8.2.1.2)

### **b) Advantages and Disadvantages**

The TO-17 method has some advantages over Methods TO-15 and 8260. One advantage is the ability to collect and concentrate a larger volume of sample, resulting in lower reporting limits because the entire volume of VOCs trapped on the sorbent tube is desorbed completely as a single aliquot of sample. In comparison, for TO-15, only a smaller sub-sample is usually analyzed at a time, resulting in elevated reporting limits. Another advantage of Method TO-17 is that this method can be used on low vapor pressure compounds such as naphthalene. Finally, the collection apparatus and sample tubes for Method TO-17 are compact and easily transportable.

However, there are disadvantages in using a sorbent tube as required by TO-17. Some of the primary disadvantages include:

- The inability to repeat an analysis on the same sample;
- Potential MS overload due to desorption of concentrated sample; and
- Column breakthrough.

The unfamiliarity of practitioners in handling and collecting soil gas samples onto sorbent tubes is another potential disadvantage, since in the United States, soil gas samples are mostly collected in canisters and syringes rather than onto sorbent tubes. Sorbent tubes, however, are used widely in Europe.

With Method TO-15, additional analysis on the same sample can be easily performed by withdrawing another sample aliquot from the sample canister. With Method TO-17, once all the compounds are desorbed from the sorbent tube the sample is completely used. Repeating a sample analysis is possible only if multiple (duplicate) sorbent tubes are collected. Multiple sorbent tubes can be collected concurrently if several sorbent tubes are manifolded in parallel during sampling. Moreover, recent advances in thermal desorption (TD) technology have made it possible to split sample into fractions for repeat runs from the same sorbent tube.

For quantification, the volume of air passing through the cartridge must be measured and documented. Moisture can be a problem with sorbent cartridges, but it can be managed by using alternative sorbents, sample splitting or dry purging (USEPA, 1999, Method TO-17, Section 7.2). The use of in-line water traps is not recommended since the traps may absorb target analytes. Other issues with TO-17



## **ADVISORY – ACTIVE SOIL GAS INVESTIGATIONS**

include interferences from sorbent artifacts (USEPA, 1999, Method TO-17, Section 7.1). There is no single universal sorbent that can be used for all possible VOCs. The choice of sorbent depends on the target VOCs. However, multi-bed (sorbent) tubes are also available that can be used to sample for a wide range of target compounds.

Method TO-17 should not be used to analyze highly concentrated soil gas samples. Highly concentrated soil gas samples will saturate the MS if completely desorbed into the GC. Therefore, the approximate concentration of VOCs or SVOCs should be predetermined by field screening specific soil gas sampling locations using another analytical method such as USEPA 5035/8260 or USEPA 5030/8260, prior to deployment.

### **USEPA Method TO-13A**

Although TO-13A (USEPA, 1999) was designed for collecting and analyzing PAHs in ambient air, this method can successfully be used for soil gas sampling and analysis.

Samples are collected/adsorbed onto a combination of filter and sorbent cartridges followed by solvent extraction, cleanup (if needed) and concentration before analysis by GC/MS. Since a soil gas sample is treated in the same manner as an ambient air sample, there should be no modification needed to analyze soil gas samples with this method. The following need to be evaluated prior to sampling:

- Volume needed to meet the required reporting limits; and
- Sampling flow rate relative to the capacity of the sampling tube.

### **Scan vs. SIM Mode**

Scan and Selected Ion Monitoring (SIM) are two data acquisition modes with GC/MS methods. The most common mode is the Scan mode in which the detector scans from high to low across a range of masses continuously. In scan mode, compound identification is made by comparing the samples mass spectrum against a spectral library. In SIM mode, only a few selected ion fragments or masses are monitored. Because the detector concentrates its time only on selected masses, the sensitivity is maximized. Due to the increase in sensitivity, lower reporting limits are possible.

Although SIM can provide lower reporting limits, its utility is limited and should only be used for a site that is completely characterized. It should never be used for initial site characterization because the instrument is set to monitor only the selected target compounds. SIM may be used to overcome some background problems in soil and water matrices. However, there are inherent matrix effects with soil gas samples; therefore, SIM is not always the best choice to use with soil gas samples.

## **MODIFIED GC METHODS**

Two primary GC methods associated with soil gas analysis are USEPA Methods 8015 and 8021. GC methods may be used for routine monitoring when the contaminants and their approximate concentrations are known. The GC method should not be used for initial characterization. When new, unknown compounds are detected, these should be confirmed by analysis with a GC/MS method. On a routine basis, at least 10 percent of positive results from GC analysis should be confirmed by analysis with a GC/MS method.

Various versions of each method exist in the SW-846 manual (USEPA 2000). Laboratories should use the most updated versions of the method and state in their analytical reports which version of the method was used.

### **USEPA Method 8015 (8015, 8015A, 8015B, 8015C and 8015D)**

USEPA Method 8015 (Non-halogenated Organics by Gas Chromatography) is used to determine the concentration of volatile and semi-volatile nonhalogenated organic compounds, triethylamine and petroleum hydrocarbons (C5-C32) (USEPA 2000). Samples are introduced into the GC by one of the following methods:

- Purge-and-trap;
- Equilibrium headspace;
- Direct injection;
- Injection of azeotropic distillation concentrate;
- Injection of vacuum distillation concentrate; and
- Injection of solvent extraction concentrate.

A FID is used with all modifications of Method 8015. In order to apply this method to soil gas samples, the same types of modifications described for Method 8260B/C should be used. Samples are either injected into a purge-and-trap sparger filled with water and purged or directly injected into the GC.

### **USEPA Method 8021 (8021, 8021A and 8021B)**

USEPA Method 8021B (Aromatic and Halogenated Volatiles by Gas Chromatography Using Photoionization and/or Electrolytic Conductivity Detectors) is used to determine the concentration of halogenated and aromatic volatile organic compounds (USEPA 2000). Samples are introduced into the GC by one of the following methods:

- Direct injection;
- Purge-and-trap;
- Headspace; and
- Injection of vacuum distillation concentrate.

Both a PID and a Hall electrolytic conductivity detector (HECD) are used with Method 8021 in either series or as a single detector. In order to apply Method 8021 to soil gas

## ADVISORY – ACTIVE SOIL GAS INVESTIGATIONS

samples, the same types of modifications described for Method 8260B/C should be used.

### **QUALITY ASSURANCE/QUALITY CONTROL (QA/QC)**

QA/QC requirements for soil gas testing should be outlined in the project-specific Quality Assurance Project Plan (QAPP) or the specific modified USEPA Method being employed. Soil gas analytical laboratories should comply with those QA/QC requirements and add additional checks as needed.

#### **QA/QC for Soil Gas Testing**

The following are the QA/QC protocols that should be included with soil gas testing. Most of these QA/QC protocols are required with USEPA methods as well as laboratory certification (see later):

##### **a) Daily Tune**

For GC/MS methods, laboratories should conduct the daily tune as specified in the respective method. The instrument must meet the tuning criteria before sample analysis.

##### **b) Initial Calibration**

The calibration curve should consist of a minimum of five points. The maximum percent relative standard deviation (%RSD) for each target compound should not exceed 30 percent. For USEPA Methods TO-15 and TO-17, two compounds are allowed up to 40 percent RSD.

##### **c) Daily Calibration (Continuing Calibration)**

The calibration curve for each compound of interest should be verified with each analytical batch, or once every 12 hours (24 hours for TO-15 and TO-17). Verification is conducted by analyzing the mid-point calibration standard. The results from the mid-point standard should be within 20 percent (30 percent for TO-15 and TO-17) of the initial calibration in order to assume the calibration curve is valid.

##### **d) End of Run Calibration Check**

A mid-level calibration standard should be run for each 20-sample batch or at the end of the run, whichever is more often. Verification is conducted by analyzing the mid-point calibration standard. The results from the mid-point standard should be within 20 percent of the initial calibration in order to ensure the calibration curve is still valid at the end of the batch run and the instrument sensitivity has not deteriorated. For USEPA 8260B/C, TO-15 and TO-17 methods, there is no requirement for this analysis. The instrument is monitored by internal standards which are added to every sample. The need for an end-of-the-run calibration check for GC/MS methods is at the discretion of the parties involved in the project and

should be based on DQOs. For those methods where there is no internal standard monitoring, the end of run calibration check may be needed to evaluate the instrument.

### **e) Method Blanks**

Method blanks are used to evaluate contamination from the analytical process. This is a sample prepared by the analytical laboratory using an analyte-free matrix and carried through the entire sample preparation and analytical procedure. The analyte-free matrix for soil gas is humidified laboratory grade ultra-pure air or ultra-pure nitrogen.

### **f) Container Blanks**

If sampling containers are reused or recycled then at least one decontaminated sample container per 20 samples or per batch, whichever is more often, should be analyzed as a container blank sample to verify the effectiveness of the decontamination procedures. Other components such as fittings and valves of the sampling stream that are subject to carryover/contamination should also be monitored. Note: This was previously referred to as the “Method Blank” in the 2003 Advisory – Active Soil Gas Investigations).

### **g) Trip Blanks**

Trip blanks consist of humidified laboratory-grade ultra-pure air. Trip blanks evaluate whether shipping and handling procedures are introducing contaminants into the samples, and if cross-contamination in the form of VOC migration has occurred between the collected VOC samples. Trip blanks are only required if samples are collected in polymer gas sampling bags or sorbent tubes for TO-17 analysis. A minimum of one trip blank per shipping container should be collected and analyzed for target compounds whenever VOC samples are shipped offsite for analysis. The trip blank containers and media should be the same as the site samples. USEPA Method TO-15 does not have specific trip blank requirements. Therefore, trip blanks are not needed if samples are collected in passivated stainless steel canisters.

### **h) Duplicate Samples**

Duplicate sample analysis evaluates the reproducibility (precision) of the sampling process. At least one duplicate sample per 20 samples or per batch, whichever is more often, should be collected and analyzed. Duplicate samples should be collected in separate containers at the same location and depth. A duplicate sample can be collected by using a T-splitter at the point of collection to divide the sample stream into two separate sample containers.

### **i) Replicate Samples**

Replicate sample analysis evaluates the reproducibility (precision) of the laboratory’s analytical ability and is used to estimate sample variability. At least one replicate

sample per 20 samples or per batch, whichever is more often, should be reanalyzed by the laboratory to assess analytical precision.

**j) Matrix Spike/Matrix Spike Duplicates (MS/MSD)**

The requirement for MS/MSD with modified USEPA Method 8260B/C is discretionary. Although MS/MSD samples are required with the USEPA 8000 series methods, there is no practical approach to apply this requirement to soil gas samples. For true MS/MSD samples, spike compounds must be added to the sample during the collection process. With soil gas samples, this is not technically feasible. The addition of a spike into the sparger with modified USEPA Method 8260B/C does not duplicate the actual condition of the sample as it is collected, processed and analyzed.

There is also no requirement for MS/MSD with USEPA Method TO-15 as the analysis of MS/MSD with TO-15 is impractical. Spike compounds are added at the same time that the sample is transferred into the concentrator. Because this does not truly assess the impact of the matrix on the recovery of the target compounds, the need for MS/MSD with Method TO-15 is at the discretion of the parties involved in the project and should be based on the data quality objectives.

**k) Laboratory Control Sample (LCS)**

LCS is a sample made with an aliquot of a clean (control) matrix similar to the sample matrix spiked with compounds that are representative of the target analytes and is used to document laboratory performance. For soil gas analysis, this QA/QC sample is not necessary since the “clean” matrix is humidified laboratory grade ultra-pure air. When prepared as such, this is equivalent to the daily calibration (continuing calibration) sample. It would be redundant to analyze this QA/QC sample; therefore, LCS samples are optional depending on the requirement of the project QAPP. Methods TO-13, TO-15 and TO-17 do not have any requirements for LCS sample analysis.

**l) Surrogates**

The use of surrogates in soil gas analysis is dependent on the method and container used. USEPA Method 8260B/C requires surrogates whereas Method TO-15 does not. Introducing surrogates into soil gas samples can present some logistical challenges, depending on the type of container being used to collect the sample. Surrogates are designed to monitor recoveries of target analytes. Therefore, they should be introduced at the point of sample collection in order to fully assess the recovery process.

For most laboratories that use modified USEPA Method 8260B/C, the surrogates are usually added to the water in the sparger either before or after the soil gas sample has been forced into the water. Vapor-phase surrogates (which are available for air analysis) can be theoretically added into soil gas sample aliquot in a gas-tight syringe just before injecting into the sparger. However, few if any laboratories are

## ADVISORY – ACTIVE SOIL GAS INVESTIGATIONS

using this practice for various reasons.

For laboratories using USEPA Method TO-15 the surrogates are added to the sample loop at the same time the soil gas sample is being loaded onto the concentrator. In both instances the surrogates are added after the sample has already been collected. There is a gap between when the sample is collected and when the sample is analyzed where there are no surrogates to monitor the process.

Commercially prepared surrogates or standards should be used. Preparing vapor internal standards or surrogates with liquid standards in either polymer gas sampling bags or glass bulbs is not recommended because of the inherent difficulty in preparing the surrogates or standards. Some laboratories add vapor surrogates immediately after sampling to samples collected in glass bulbs. The vapor surrogates are actually liquid surrogates injected into a glass bulb and allowed to expand. Aliquots of the vapor surrogates are injected into the glass bulb with the soil gas sample. The internal standards or surrogates should be completely vaporized before aliquots are taken. Droplets of liquid standards or surrogates can adhere to the internal surface of the bags or bulbs. Due to variations with where and when the surrogates are added to the soil gas samples, laboratories are advised to note in their final analytical reports the exact step in the process where the surrogates (if used) are added so the results can be evaluated accordingly.

### **m) Reporting Limit Verification**

The RL is the limit of quantification reported by the analyzing laboratory. The RL should not be lower than the lowest calibration point. The RL should be validated periodically (recommended with each batch of samples) by spiking a blank sample at the RL level. There is no limit on the number of samples per batch for RL verification. If the RL is set at the lowest calibration point then verification is not needed.

### **n) Acceptance Limits**

Based on laboratory performance, laboratories should establish their own acceptance limits for their QA/QC parameters. QA/QC parameters include percent recoveries for surrogates, matrix spikes, laboratory control samples and percent relative difference for duplicates. The limits should be evaluated and updated periodically. For guidance on establishing acceptance limits consult USEPA Method 8000B (December 1996), Section 8.0 of SW-846 (USEPA 2000).

**o) Standard Operating Procedures**

Laboratories should have detailed written Standard Operating Procedures (SOP) for their soil gas sampling and testing procedures. Copies of the SOP should be available in the laboratory for review and reference. The SOP should be reviewed on an annual basis and updated as needed. Field procedures, including sampling procedures, can be written as a separate SOP from the laboratory analytical procedures.

**DATA REVIEW**

All soil gas data should be reviewed in detail to ensure all QA/QC parameters are within specified control limits.

Soil gas data should be reviewed and evaluated as described in the most current version of DTSC's *"Guidance for the Evaluation of Subsurface Vapor Intrusion to Indoor Air"*.

**DETECTION LIMITS VERSUS REPORTING LIMITS**

A detection limit is defined as the *"the minimum concentration of a substance that can be measured and reported with 99 percent confidence that the analyte concentration is greater than zero, and is determined from analysis of a sample in a given matrix type containing the analyte"* (SW-846, Chapter One, Quality Control, Revision 1, July 1992). A RL is defined as the lowest concentration of an analyte that can be detected in a sample by the given analytical procedure taking into account sample matrix, interferences, dilution factor and the lowest point of the calibration curve. Laboratories should use the RL in their analytical reports since it is a more reliable indicator of the limit of detection.

**Reporting Limits**

Reporting limits should be selected prior to choosing analytical methods and be based on project DQOs. Sampling protocols, analytical method(s) used, list of target compounds, and other DQOs should be considered when selecting project RLs. For risk assessments, the reporting limits should be lower than the California Human Health Screening Levels (CHHSLs) for soil gas. For compounds that are not on the CHHSL listing, the analytical method should be selected to achieve the reporting limits for risk-based decision making.

Table F-4 delineates the reporting limits of the common soil gas analytical techniques for select analytical methods. The ranges in this table are based on a survey of analytical laboratories conducted by the Soil Gas Advisory Workgroup. For the reporting limits of other methods/techniques, consult with the analytical laboratory.

**TABLE F-4  
Reporting Limits**

Analytical Method/Technique	Reporting Limit Range*	Comments
Modified USEPA 8260B/C: Direct injection of soil gas into sparger with water.	20 – 5000 $\mu\text{g}/\text{m}^3$ (most compounds at 1000 $\mu\text{g}/\text{m}^3$ or lower)	Sample size dependent. Most samples are 5-250 cc (mL).
Modified USEPA 8260B/C: Direct injection of soil gas into GC column.	100 – 1000 $\mu\text{g}/\text{m}^3$	
Modified USEPA TO-15 (Conventional GC/MS system).	Scan Mode: 0.7 – 200 $\mu\text{g}/\text{m}^3$ SIM Mode: 0.004 – 0.20 $\mu\text{g}/\text{m}^3$	
Modified USEPA TO-15 (Using portable GC/MS system (e.g., Hapsite®)).	4 – 100 $\mu\text{g}/\text{m}^3$	

**Reporting Units**

Analytical laboratories should report soil gas results in  $\mu\text{g}/\text{m}^3$  rather than  $\mu\text{g}/\text{L}$  or parts per billion by volume (ppbv). Although 1,000  $\mu\text{g}/\text{m}^3$  is equivalent to one  $\mu\text{g}/\text{L}$ , neither can be converted to ppbv by simply moving the decimal point. The ppbv conversion is a function of the molecular weight of the compound in question, as shown in the example below. Environmental practitioners should verify that soil gas sample results are calculated correctly and reported in the proper units.

Example: benzene in air/soil gas with molecular weight=78.11 is converted as follows:

$$1.0 \mu\text{g} / \text{L Benzene} = 1000 \mu\text{g} / \text{m}^3 \text{ Benzene} = 315 \text{ ppbv Benzene}^*$$

$$*\text{ppbv} = [(\mu\text{g}/\text{L}) \times (\text{RT})] \times 1000 / (\text{MW}) \times \text{P} \quad \text{or} \quad \text{ppbv} = [(\mu\text{g}/\text{m}^3) \times (\text{RT})] / (\text{MW}) \times \text{P}$$

where:

$$\begin{aligned} \mu\text{g}/\text{L} &= 1.0 \\ \mu\text{g}/\text{m}^3 &= 1000 \\ \text{R} &= 0.0825 \text{ L-atm/mole-}^\circ\text{K (Ideal Gas Law Constant)} \\ \text{T} &= 298^\circ\text{K (Standard Temperature)} \\ 1000 &= \text{Conversion of } 1 \text{ m}^3 = 1000 \text{ L} \\ \text{MW} &= 78.11 \text{ (Molecular Weight of Benzene)} \\ \text{P} &= 1 \text{ atm (Standard Pressure)} \end{aligned}$$

Laboratories using TO methods generally report results in ppbv, and may continue to do so, but should also provide the conversion to  $\mu\text{g}/\text{m}^3$ .



## VARIABILITY AND COMPARING RESULTS

Variability in soil gas results comes from differences in the laboratory instruments, sample introduction techniques, and the analyst's skill, experience and practices, as well as variability in field sample collection methods and in sample containers. Finally, there is also a variation in the sample matrix. A replicate sample collected immediately after the original sample may not be the same due to spatial and temporal differences.

To evaluate the comparability of results from two different methods, calculate the Relative Percent Difference (RPD) of the results. The RPD is calculated with the formula:

$$RPD = 100 \times (C_1 - C_2) / [(C_1 + C_2) / 2]$$

where:  $C_1$  = Result from the first method  
 $C_2$  = Result from the second method

In instances where soil gas results from the same source analyzed by two different methods differ by more than 50 percent RPD, the results should be validated. Validation involves reviewing the sampling procedures, collection containers, sample introduction technique and QA/QC data. Any differences should be evaluated and explained. All QA/QC results should be reviewed to make sure the parameters are within the established control limits and the calculations checked. The final analytical results from modified 8260B/C should be reported and calculated as  $\mu\text{g}/\text{m}^3$  or  $\mu\text{g}/\text{L}$  (see section above on reporting units).

Some compounds are better analyzed by one method than the other due to their physical nature. Some compounds have a better recovery if a liquid standard is used whereas, the vapor phase standard will purge poorly. Highly volatile VOCs are recovered well with modified 8260B/C compared to TO-15. Resampling and reanalyzing samples may be necessary if the recovery discrepancies cannot be explained after validation.

## METHOD REFERENCES IN ANALYTICAL REPORTS

The analytical method used to test soil gas samples and any modifications to the analytical method should be described in the laboratory reports. Refer to the Performance-Based Measurement Systems Section above for information on referencing PBMS.

## LABORATORY CERTIFICATION

All laboratories performing soil gas testing should be certified. According to the California Health and Safety Code Section 25356.1.5(e), exposure assessments shall include development of reasonable maximum estimates or exposure to VOCs that may enter existing or future structures on a site. Section 25358.4 requires that analysis of any material, that is required to show compliance with Chapter 6.8 of the Health and

## ADVISORY – ACTIVE SOIL GAS INVESTIGATIONS

Safety Code, shall be performed by a laboratory accredited by the Department of Public Health pursuant to Article 3 of Chapter 4 of Part 1 of Division 101.

Soil gas testing laboratories can obtain certification from the California Department of Public Health's Environmental Laboratory Accreditation Program (ELAP) for all analytical methods they are using for soil gas testing. Certification ensures that the laboratories have the requisite facilities, equipment and personnel to perform the testing, and have demonstrated competence and compliance with the methods being certified.

In addition, certification entails the validation of the analytical method as well as periodic checks with performance evaluation or blind samples (where available) to assess laboratory continued competence with the method.

Soil gas certification for USEPA Methods 8015, 8021, 8260, TO-13A, TO-15 and TO-17 is available from ELAP.

National Environmental Laboratory Accreditation Program (NELAP) accreditation for USEPA Methods TO-13A, TO-15 and TO-17 should be accepted in lieu of California ELAP certification for soil gas testing.

Laboratories that have either certification from ELAP or NELAP for USEPA Methods 8015, 8021 or 8260B for either soil or water matrices should obtain separate certification from ELAP for soil gas work with those methods.

ELAP will provide certification for PBMS as warranted. PBMS may be new techniques using available equipment, an entirely new method with novel techniques and equipment, or modifications of known published methods. PBMS must meet the criteria below:

- The process can be validated;
- It can be demonstrated that the process can meet project data quality objectives; and
- It can be demonstrated that the process can meet the specified method performance criteria.

## REFERENCES

Hartman, B. 2006. How to Collect Reliable Soil-Gas Data for Risk-Based Applications-Specifically Vapor Intrusion; Part 4-Updates on Soil-Gas Collection and Analytical Procedures, LUSTLine Bulletin 53, September 2006.

USEPA. 1999. *Compendium of Methods for the Determination of Toxic Organic Compounds in Ambient Air*. Methods TO-13, TO-15, TO-17, Second Edition, U.S. Environmental Protection Agency, Research Triangle Park, North Carolina, January 1999; EPA 600/625/R-96/010b.

## ADVISORY – ACTIVE SOIL GAS INVESTIGATIONS

USEPA. 2000. *Test Methods for Evaluating Solid Waste, Physical/Chemical Methods, EPA Publication SW-846, Third Edition*, November 1986, as amended by Updates I (Jul. 1992), II (Sep. 1994), IIA (August 1993), IIB (Jan. 1995), III (Dec. 1996), IIIA (Apr. 1998), IVA (Jan. 1998) and IVB (Nov. 2000).

## APPENDIX G      BAROMETRIC PRESSURE, RAINFALL, AND SOIL DRAINAGE

### BAROMETRIC PRESSURE FLUCTUATIONS

#### Soil Gas

Massmann and Farrier (1992) evaluated the significance of barometric pressure fluctuations on the transport of atmospheric gas into the vadose zone. They examined situations in which barometric fluctuations will yield a significant effect on the vadose zone. Model calculations showed that fresh air may migrate several meters into a highly permeable subsurface during large barometric pressure cycles and the depth of penetration increases as the thickness and permeability of the vadose zone increases. Massmann and Farrier (1992) thus suggested that the concentration of volatile contaminants may be lower when barometric pressures are high and that soil gas measurements will show the largest fluctuations during times of rapidly rising or falling barometric pressures. During these large barometric pressure changes, as indicated by Figure 8 of their paper, soil gas at 1.5 meters (5 feet) may be diluted with atmospheric air by 30 to 50 percent.

#### Surface Flux

Clements and Wilkening (1974) demonstrated empirically that atmospheric pressure changes of one to two percent associated with the passage of frontal systems will produce changes in the flux of radon from the subsurface by 20 to 60 percent. The actual magnitude of the change in the radon flux depends upon the rate of change of the barometric pressure and its duration. The effect of pressure changes on VOC concentrations in soil gas is expected to be similar.

### RAINFALL EVENTS

#### Surface flux

Kienbusch and Ranum (1986) evaluated the effects of rainfall on the collection of flux chamber measurements on open ground. In tests at a simulated landfill, water was added to dry soil cells to simulate rainfall. Trace precipitation (0.01 inches) had no effect on measured emission fluxes from the ground. Heavier rainfall (0.4 inches), however, did have an effect. The emission flux was decreased by 90 to 95 percent and the reduction in emissions lasted for over eight days. These results are consistent with other field observations (Radian Corporation, 1984; Eklund, 1992).

**Soil Drainage**

Gardner and others (1970) derived approximate solutions for unsaturated flow following irrigation. Their solutions can be used to evaluate the impact of rainfall on subsurface moisture conditions. The drainage of soil by gravity following infiltration of one centimeter of water for two soil types, sand and silt, is shown in Figure G-1. The initial unsaturated hydraulic conductivity within the infiltration zone for the silt and sand was assumed to be one centimeter per day and 1000 centimeters per day, respectively. An instantaneous infiltration of one centimeter was used in the evaluation. The figure demonstrates that drainage to approximately asymptotic moisture conditions occurred within about five days for these two soil types.

**FIGURE G-1**

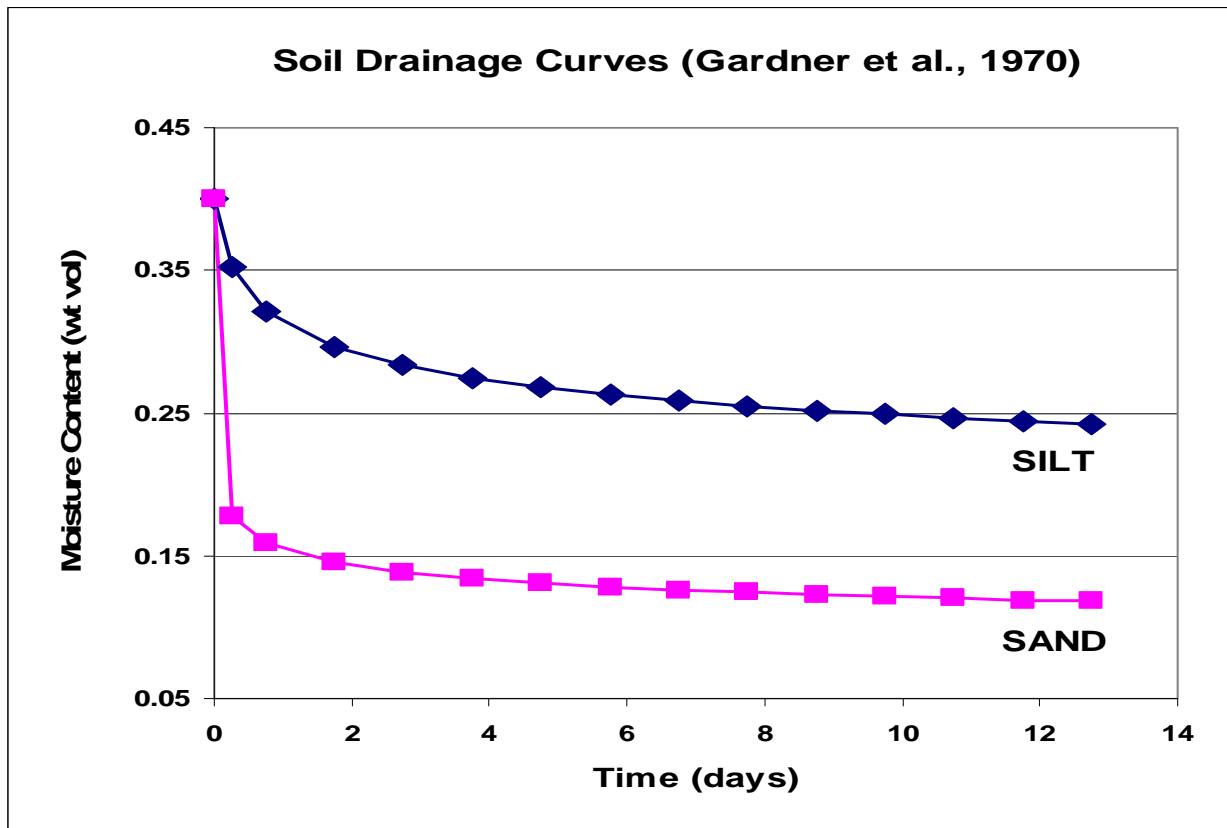

Likewise, Sisson and others (1980) derived a one-dimensional unsaturated flow equation to evaluate water movement in the vadose zone. Soil drainage curves from Sisson and others (1980) where a unit gradient was assumed are shown in Figure G-2. The figure denotes a silty sand scenario where the initial unsaturated hydraulic conductivity was assumed to be 100 centimeters per day. The model assumed that the vadose was saturated to 0.40 and allowed to drain. Moisture profiles are shown for five different time intervals. The figure demonstrates that drainage to near ambient moisture conditions of 0.10 occurred within about five days, agreeing with the approximations by Gardner and others (1970).

FIGURE G-2

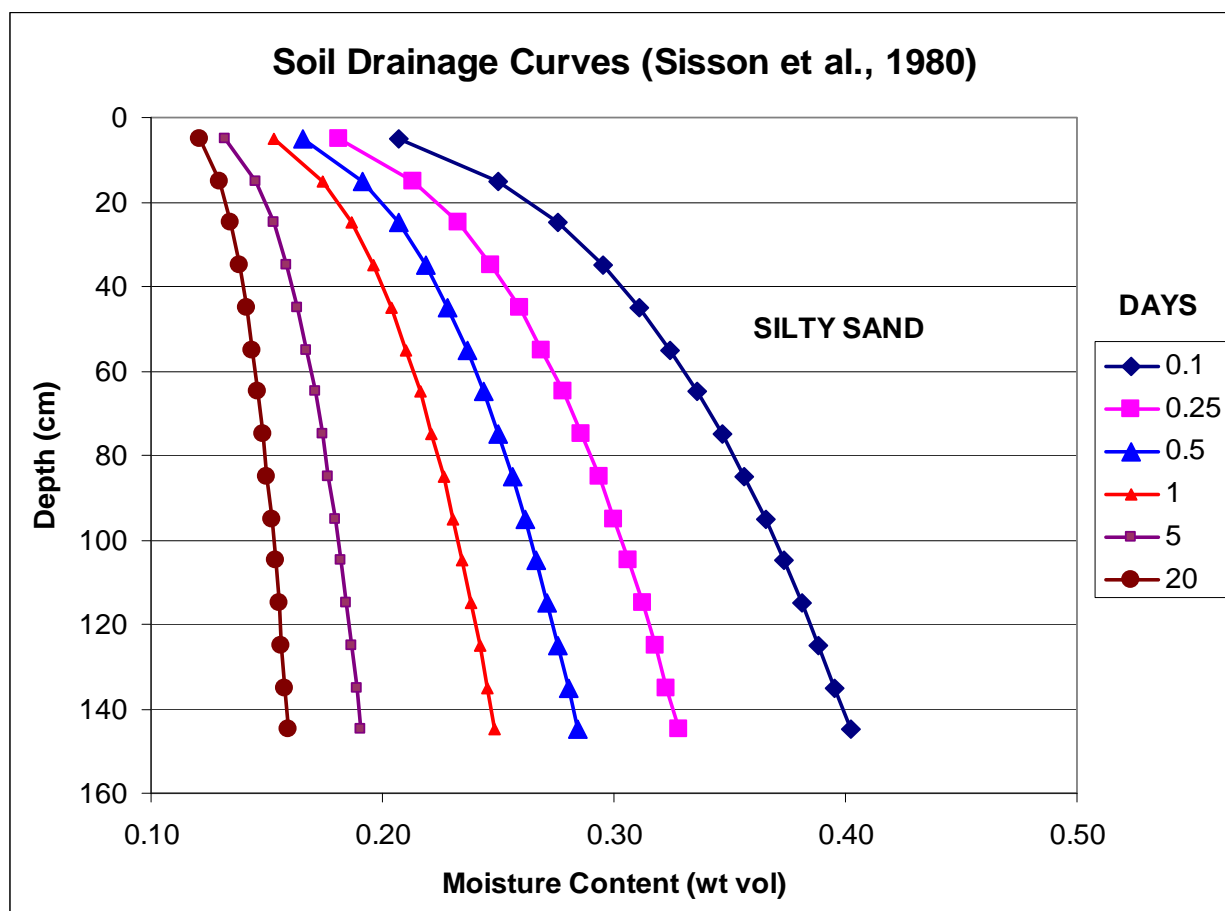

**REFERENCES**

Clements, W. E., and M. Wilkening. 1974. *Atmospheric Pressure Effects on <sup>222</sup>Rn Transport Across the Earth-Air Interface*. Journal of Geophysical Research, v. 79, n. 33, p. 5025 - 5029.

Gardner, W. R., D. Hillel, and Y. Benyamini. 1970. *Post-Irrigation of Soil Water, 1. Redistribution*. Water Resources Research, v. 6, n. 3, p. 851 – 861.

Kienbusch, M., and D. Ranum. 1986. *Validation of Flux Chamber Emission Measurements on a Soil Surface*. Draft Report to EPA-EMSL, Las Vegas, Nevada, EPA Contract No. 68-02-3889, Work Assignment 69, June 1986.

Massmann, J., and D. F. Farrier. 1992. *Effects of Atmospheric Pressures on Gas Transport in the Vadose Zone*. Water Resources Research, v. 28, n. 3, p. 777 - 791.

Radian Corporation. 1984. *Soil Gas Sampling Techniques of Chemicals for Exposure Assessment – Data Volume*. Report to EPA-EMSL, Las Vegas, Nevada, EPA Contract No. 68 -02-3513, Work Assignment 32, March 1984.

**ADVISORY – ACTIVE SOIL GAS INVESTIGATIONS**

Sisson, J. B., A. H. Ferguson, and T. Th. van Genuchten. 1980. *Simple Method for Predicting Drainage from Field Plots*. Soil Science Society of America Journal, v. 44, p. 1147 – 1152.

## APPENDIX H REPORTING FORMAT AND PARAMETERS

### RECORDKEEPING IN THE MOBILE LABORATORY

The following records concerning calibration standards and QA/QC should be maintained as hard copies in the mobile laboratory:

- a) Date of calibration standard receipt;
- b) Name of calibration supplier;
- c) Calibration lot number;
- d) Date of preparation for intermediate standards (dilution from the stock or concentrated solution from supplier);
- e) Calibration ID number or other identification data;
- f) Name of technician who performed the dilution;
- g) Volume of concentrated solution taken for dilution;
- h) Final volume after dilution;
- i) Calculated concentration after dilution;
- j) The latest and current initial calibration data for each instrument used; and
- k) The currently-used laboratory standard operating procedures.

### REPORTING OF SOIL GAS SAMPLE RESULTS AND QA/QC DATA

- 1) Report all sample test results for all compounds in the analyte list and QA/QC data. Compounds may be listed by retention time or in alphabetical order. Report any unidentified or tentatively identified peaks. Submit all data in electronic format and raw data, including the chromatograms for samples and standards, as requested.
- 2) Report the following for all calibration standards, QA/QC standards, and soil gas samples:
  - a) Site name;
  - b) Laboratory name;
  - c) Date of analysis;
  - d) Initials of analyst;
  - e) Instrument identification;
  - f) Injection amount;
  - g) Injection time;
  - h) Concentrations of each analysis;
  - i) Laboratory quality control limits;
  - j) Calculated results; and
  - k) Notes or explanation of any outliers



## ADVISORY – ACTIVE SOIL GAS INVESTIGATIONS

- 3) Provide additional information, as specified, for different types of analyses. Tabulate and present in a clear legible format all information according to the following grouping:

### a) Initial calibration

- i) Source of standard (STD Lot ID No.);
- ii) Detector;
- iii) Retention time (RT);
- iv) Standard mass or concentration;
- v) Peak area;
- vi) Response factor (RF);
- vii) Average response factor ( $RF_{Ave}$ );
- viii) Standard deviation ( $SD_{n-1}$ ) of RF;
- ix) Percent relative standard deviation (% RSD); and
- x) Acceptable range of %RSD (ACC RGE).

### b) Daily calibration check sample and Laboratory Control Sample (LCS)

- i) Source of standard;
- ii) Detector;
- iii) Retention time (RT);
- iv) Standard mass or concentration;
- v) Peak area;
- vi) Response factor (RF);
- vii) Percent difference between RF and  $RF_{Ave}$  from initial calibration (% DIFF); and
- viii) Acceptable range of %DIFF (ACC RGE).

### c) Soil Gas Sample

- i) Sample identification;
- ii) Sampling depth;
- iii) Purge volume;
- iv) Vacuum pressure;
- v) Sampling date and time;
- vi) Injection date and time;
- vii) Injection amount;
- viii) Dilution factor (or concentration factor if trap is used);
- ix) Detector;
- x) Retention time (RT);
- xi) Peak area;
- xii) Concentration in either  $\mu\text{g/L}$  or  $\mu\text{g/m}^3$ . Specific reporting units should be specified in the QAPP;
- xiii) Total number of peaks found by each detector;
- xiv) Unidentified peaks and/or other analytical remarks;
- xv) Surrogate results; and
- xvi) Control limits.